

**IP Intercom**

**DSP9322A**

**DSP9322B**



DSP9322A



DSP9322B

# User Manual

---

Thank you for using our DSPPA public address system. Please read this User Manual carefully to make better use of this equipment.

**Guangzhou DSPPA Audio Co., Ltd.**

<http://www.DSPPA.com>

<http://www.dsppatech.com>

# Safety Notices

1. Please use the specified power adapter. If special circumstances need to use the power adapter provided by other manufacturers, please make sure the voltage and current provided in accordance with the requirements of this product, meanwhile, please use the safety certificated products, otherwise may cause fire or get an electric shock.
2. When using this product, please do not damage the power cord, or forcefully twist it, Stretch pull or banding, and not to be under heavy pressure or between items, Otherwise may cause the power cord damage, thus lead to fire or get an electric shock.
3. Before use, please confirm the temperature and environment humidity suitable for the product work. (Move the product from air conditioning room to natural temperature, which may cause this product surface or internal components produce condense water vapor, please open power use it after waiting for this product is natural drying).
4. Non-technical staff not remove or repair, improper repair or may cause electric shock, fire or malfunction, etc, Which can lead to injury accident, and also can cause your product damage.
5. Do not use fingers, pins, wire and other metal objects, foreign body into the vents and gaps. It may cause current through the metal or foreign body, which even cause electric shock and injury accident. If any foreign body or objection falls into the product please stop usage.
6. Please do not discard the packing bags or stored in places where children could reach, if children trap his head with it, may cause nose and mouth blocked, and even lead to suffocation.
7. Please use this product with normal usage and operating, in bad posture for a long time to use this product may affect your health.
8. Please read the above safety notices before installing or using this phone. They are crucial for the safe and reliable operation of the device.

## Directory

<b>A. PRODUCT INTRODUCTION .....</b>	<b>5</b>
<b>1. APPEARANCE OF THE PRODUCT.....</b>	<b>5</b>
<b>2. BUTTON DESCRIPTION .....</b>	<b>5</b>
<b>B. START USING .....</b>	<b>5</b>
<b>1. CONNECTING THE POWER SUPPLY AND THE NETWORK .....</b>	<b>5</b>
<b>(1) Connecting network .....</b>	<b>5</b>
<b>(2) Interface specification .....</b>	<b>6</b>
<b>a) Schematic diagram of peripherals.....</b>	<b>6</b>
<b>b) Interface specification.....</b>	<b>6</b>
<b>c) Port instructions.....</b>	<b>8</b>
<b>2. QUICK SETTING .....</b>	<b>10</b>
<b>C. BASIC OPERATION .....</b>	<b>10</b>
<b>1. ANSWER A CALL .....</b>	<b>10</b>
<b>2. CALL .....</b>	<b>10</b>
<b>3. END CALL .....</b>	<b>11</b>
<b>4. CALL RECORD .....</b>	<b>11</b>
<b>D. PAGE SETTINGS.....</b>	<b>11</b>
<b>1. BROWSER CONFIGURATION.....</b>	<b>11</b>
<b>2. PASSWORD CONFIGURATION.....</b>	<b>11</b>
<b>3. CONFIGURATION VIA WEB.....</b>	<b>12</b>
<b>(1) BASIC.....</b>	<b>12</b>
<b>a) STATUS.....</b>	<b>12</b>
<b>b) WIZARD.....</b>	<b>13</b>
<b>c) CALL LOG .....</b>	<b>15</b>
<b>d) LANGUAGE.....</b>	<b>15</b>
<b>e) TIME&amp;DATE .....</b>	<b>16</b>
<b>(2) NETWORK.....</b>	<b>17</b>
<b>a) WAN.....</b>	<b>17</b>
<b>b) LAN.....</b>	<b>20</b>
<b>c) QoS&amp;VLAN.....</b>	<b>20</b>
<b>d) WEB FILTER .....</b>	<b>23</b>
<b>e) FIREWALL.....</b>	<b>23</b>
<b>f) VPN.....</b>	<b>24</b>
<b>g) SECURITY .....</b>	<b>26</b>
<b>(3) VOIP .....</b>	<b>26</b>
<b>a) SIP.....</b>	<b>26</b>
<b>b) STUN .....</b>	<b>29</b>
<b>(4) Intercom .....</b>	<b>31</b>

a) FUNCTION KEY .....	31
b) AUDIO.....	33
c) FEATURE .....	34
d) MCAST.....	36
e) Action URL .....	38
(5) SAFEGUARDING.....	39
(6) MAINTENANCE .....	41
a) AUTO PROVISION .....	41
b) SYSLOG.....	43
c) CONFIG .....	44
d) UPDATE.....	44
e) ACCESS .....	45
f) REBOOT .....	45
(7) LOGOUT .....	46
<b>E. APPENDIX.....</b>	<b>47</b>
1. TECHNICAL PARAMETERS.....	47
2. BASIC FUNCTIONS .....	48
3. SCHEMATIC DIAGRAM.....	48
4. THE RADIO TERMINAL CONFIGURATION NOTICE .....	49
5. THE OTHER FUNCTION SETTINGS .....	50

## A. Product introduction

This product is a fully digital network intercom equipment, its core part adopts mature VOIP solutions (Broadcom 1190), the performance is stable and reliable; the digital full duplex hands-free, voice loud and clear; the keys feel comfortable, simple installation, appearance, durable, low power consumption.

### 1. Appearance of the product



### 2. Button description

Buttom	Description	Function
	programmable keys	Can be set to a variety of functions, in order to meet the needs of different occasions

## B. Start Using

Before you start to use equipment, please make the following installation:

### 1. Connecting the power supply and the network

#### (1) Connecting network

In prior to this step, please check if your network can work normally and have capacity of broadband internet access.

● **Broadband Router**

Connect one end of the network cable to the intercom WAN port, the other end is connected to your broadband router's LAN port, so that the completion of the network hardware connections. In most cases, you must configure your network settings to DHCP mode. Please refer to the detailed setting ways: **D, 3, (2), a) WAN.**

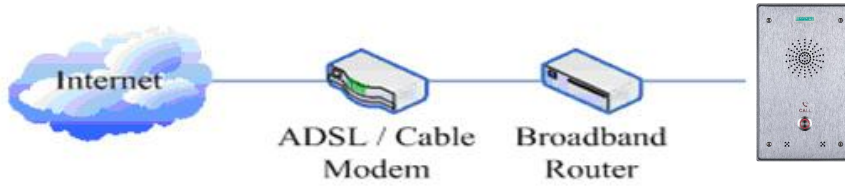

● **No Broadband Router**

Connect one end of the network cable to the intercom WAN port, the other end is connected to the broadband modem to your LAN port, so that the completion of the network hardware connections. In most cases, if you are using the cable broadband, you must configure your network settings to DHCP mode; if you are using the ADSL, you must configure your network settings to PPPoE mode. Please refer to the detailed setting ways: **D, 3, (2), a) WAN.**



**(2) Interface specification**

**a) Schematic diagram of peripherals**

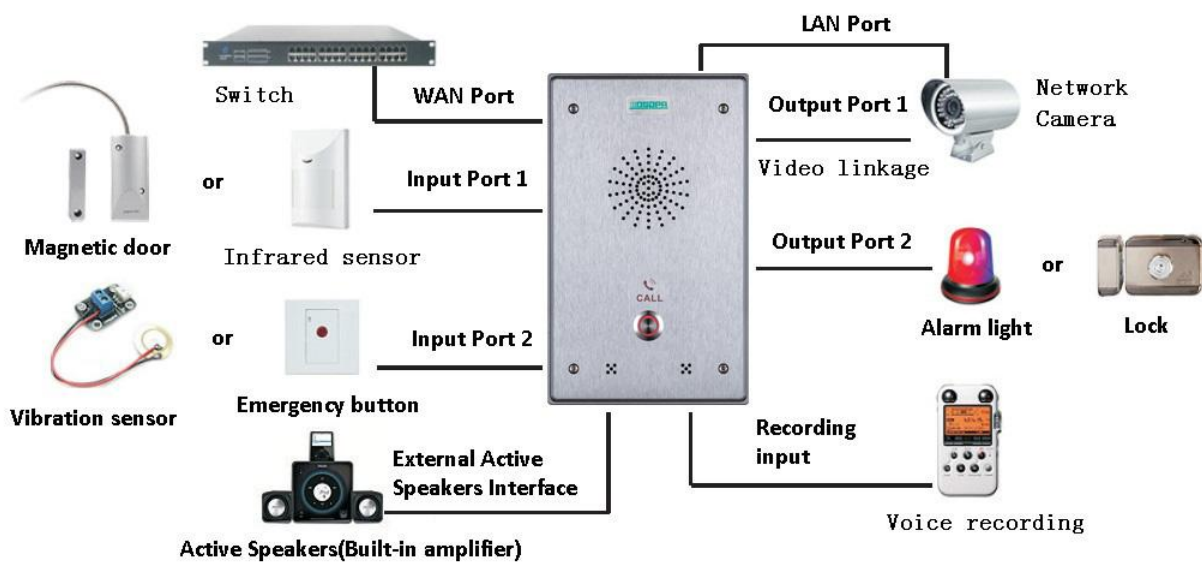

**b) Interface specification**

● Expansion board interface

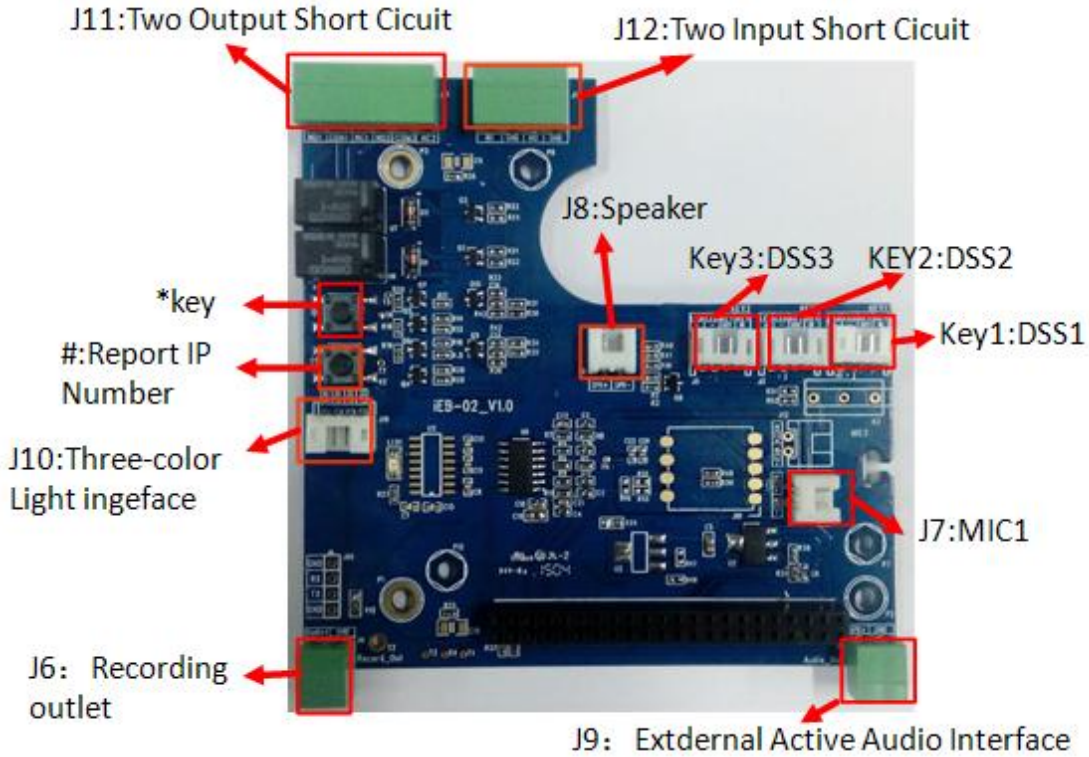

[Notice] Press “#”key for 3 seconds, the controller will report it IP number by itself.

● Motherboard interface

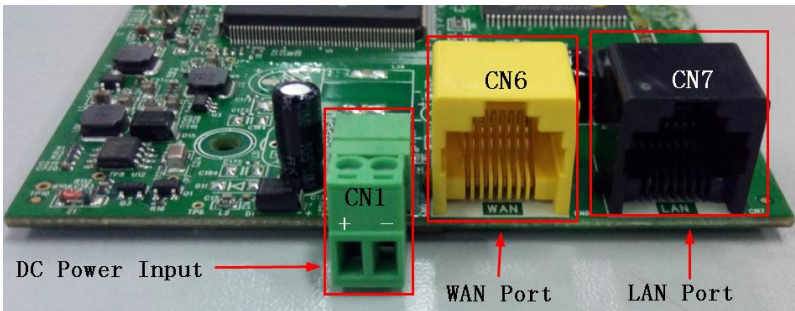

CN1	CN6	CN7
Power Supply	WAN Port	LAN Port
+9~+16V	WAN	LAN
		

[Notice] LAN port Support two modes:

- ◇ Routing mode (It can assign IP Address to LAN port the via the DHCP for each connected device)
- ◇ Bridge Mode (LAN port and WAN port are in the same network segment)

● **Port description**

Port	Description	Feature	Picture
CN1	DC Power Input port	Input Range:+9~+16V DC  (Notice: Plus-n-Minus connection of the Power)	
CN6	WAN port	10M/100M Adaptive Ethernet port, connected to the network	
CN7	LAN Port	10M/100M Adaptive Ethernet port, connected to the computer  (which can be configured to routing mode, or to bridge mode)	
J9	External Active Speakers port	One is the audio signal line, one is the GND line(Please connect to the GND line, otherwise there will be noise)	
J6	Audio Recording output port	By mixing equipment and remote call voice output.  One is the audio signal line, one is the GND line(Please connect to the GND line, otherwise there will be noise)	
Key1/key2/ key3	DSS key port  (programmable keys)	Function keys. Can be defined hot keys, function keys(such as hanging up, hands-free), multicast keys	
J11	Short circuit output control Port	Used to control electric locks, alarm lamp and so on	
J12	Short circuit Input detection Port	Used to connect to infrared detector, magnetic switch, vibration sensor and other input devices	
J10	Status indicator light port	For an external status instructions (calling, ringing, network/registered)	

c) **Port instructions**

● **External Active Speakers**



J9: External Active Speakers Port	
2	1
SPK+	GND
Audio output port	Ground Line
	

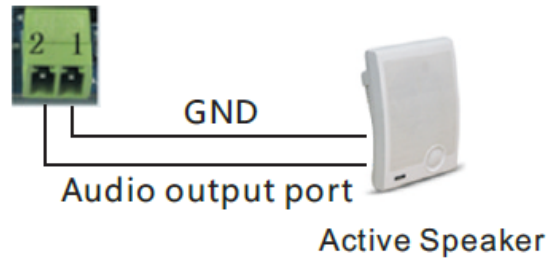

● Audio Recording output port

J6: Audio Recording output port	
2	1
Audio+	GND
Audio Recording output port	Ground Line
	

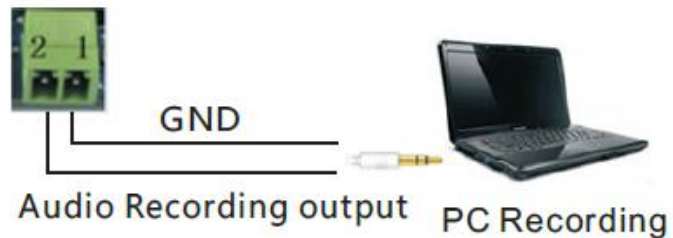

● Two short circuit output port

- NO: Under the idle state is disconnected (normally open).
- COM: Contactor of the Relay (middle).
- NC: Under the idle state is connected (normally close).

J11: Short circuit output Port					
Output Port1(OUT2)			Output Port1(OUT1)		
6	5	4	3	2	1
NC2	COM2	NO2	NC1	COM1	NO1
Normal close	Common terminal	Normal Open	Normal close	Common terminal	Normal Open
					

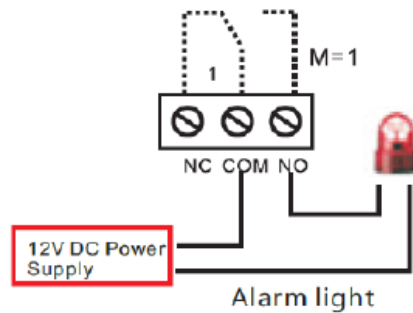

● Two short circuit input port

J12: Short circuit Input Port			
Input Port2(IN2)		Input Port1(IN1)	
4	3	2	1
GND	IN2	GND	IN1
Input Port2	Input Port2	Input Port1	Input Port1
			

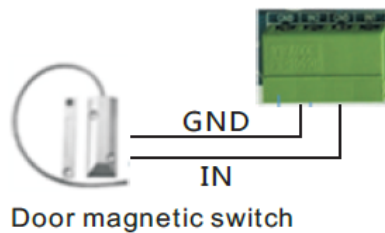

● Status lamp interface

J10: Status lamp interface			
4	3	2	1
3.3V	LED1	LED2	LED3
Power supply	Network	Call	Ringing

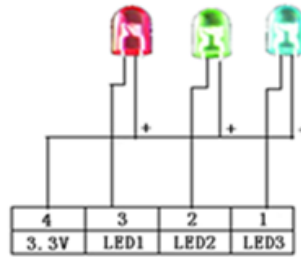



## 2. Quick Setting

The product provides a rich and complete function and parameter setting; users may need to have a network with SIP protocol in order to understand the related knowledge on behalf of all the significance of the parameters. In order to high quality voice service and low cost advantage, allowing users to enjoy the facility brought fast, especially in the listed in this section the basic and necessary to set options users can quickly get started, no without understanding the complicated SIP protocol.

In this step, please confirm the Internet broadband access can be normal operation, and complete the connection to the network hardware. The intercom default for DHCP mode.

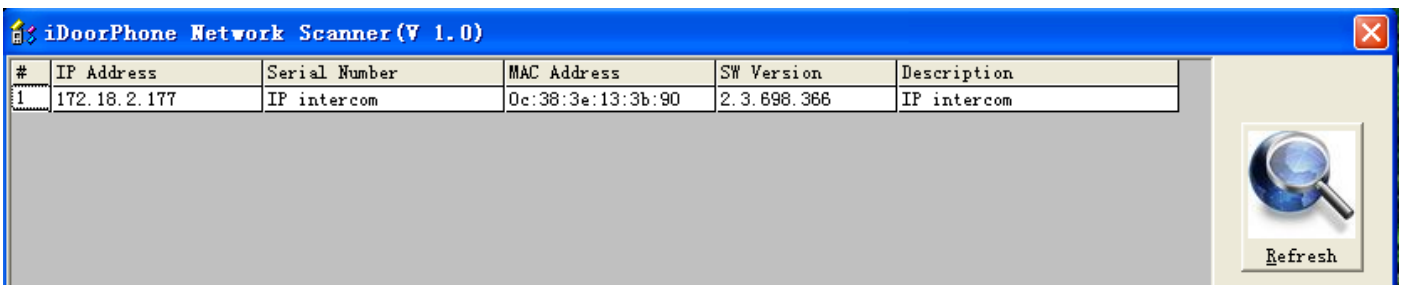
- A long press # key 3 seconds, automatic voice playing device's IP address, or use the "iDoorPhoneNetworkScanner.exe" software to find the IP address of the device.
- Log on to the WEB device configuration.
- In a SIP page configuration service account, user name, parameters that are required for server address register.
- You can settings DSS key in the Webpage(functions key settings -> function key).
- You can settings function parameters in the Webpage (Intercom-> feature).



## C. Basic operation

### 1. Answer a call

When calling come, the device automatically answer, in cancel automatic answer and settings automatic answer time, will hear the bell in the set time, automatic answer after a timeout.

### 2. call

Configuration shortcut as hot key and setup a number, then press shortcut can call the configured

number immediately.

### 3. End call

Enable Release key hang up to end call.

### 4. Call record

The device provides 300 call recording, when the storage space is exhausted, will cover the first call records. When the device is powered down or reboot, call records will be removed.

You can view the three call records in the Webpage (Basic->call log)

## D. Page settings

### 1. Browser configuration

When the device and your computer successfully connected to the network, the on browsers enter the IP address of the device. You can see the Webpage management interface the login screen.

Enter the user name and password and click [logon] button to enter the settings screen.

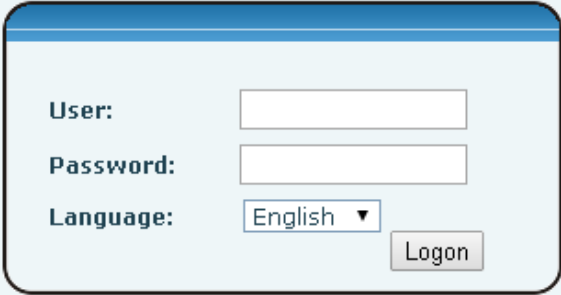

The image shows a login interface with the following elements:

- User:** A text input field.
- Password:** A text input field.
- Language:** A dropdown menu with 'English' selected.
- Logon:** A button to submit the login information.

After configuring the equipment, remember to click SAVE under the Maintenance tab. If this is not done, the equipment will lose the modifications when it is rebooted.

### 2. Password Configuration

There are two levels of access: root level and general level. A user with root level access can browse and set all configuration parameters, while a user with general level can set all configuration parameters except server parameters for SIP.

- Default user with general level:
  - ◆ Username: guest
  - ◆ Password: guest
- Default user with root level:
  - ◆ Username: admin
  - ◆ Password: admin

### 3. Configuration via WEB

#### (1) BASIC

##### a) STATUS

Network			
WAN	LAN		
Connection Mode	DHCP	IP Address	192.168.10.1
MAC Address	00:d8:4a:00:02:ba	DHCP Service	Enabled
IP Address	172.18.2.112	Bridge Mode	Disabled
IP Gateway	172.18.1.1		

Accounts		
SIP Line 1	@:5060	Unapplied
SIP Line 2	@:5060	Unapplied

Status	
Field Name	Explanation
Network	Shows the configuration information for WAN and LAN port, including connection mode of WAN port (Static, DHCP, PPPoE),MAC address, IP address of WAN port and LAN port, DHCP server, status for LAN port (ENABLED or DISABLED). Default Static IP: 192.168.1.128
Accounts	Shows the phone numbers and registration status for the 2 SIP LINES and 1 IAX2 server.

**b) WIZARD**

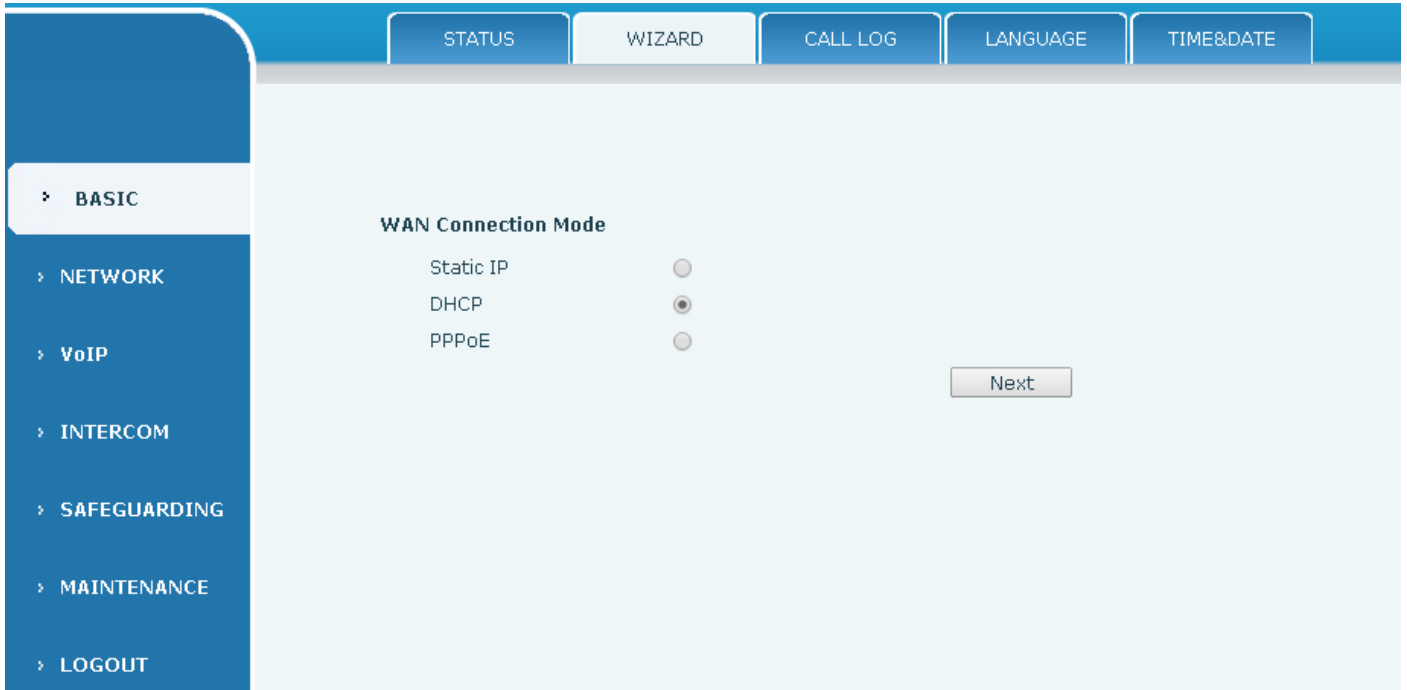

Wizard	
Field Name	Explanation
Select the appropriate network mode. The equipment supports three network modes:	
Static IP mode	The parameters of a Static IP connection must be provided by your ISP.
DHCP mode:	In this mode, network parameter information will be obtained automatically from a DHCP server.
PPPoE mode:	In this mode, you must enter your ADSL account and password.
<b>Static IP mode is selected; Click Next to go to Quick SIP Settings, Click Back to return to the Wizard screen.</b>	
<div style="border: 1px solid #ccc; padding: 5px;"> <p><b>Static IP Settings</b></p> <p>IP Address: <input type="text" value="192.168.1.179"/></p> <p>Subnet Mask: <input type="text" value="255.255.255.0"/></p> <p>IP Gateway: <input type="text" value="192.168.1.1"/></p> <p>DNS Domain: <input type="text"/></p> <p>Primary DNS: <input type="text" value="202.96.134.133"/></p> <p>Secondary DNS: <input type="text" value="202.96.128.68"/></p> <p style="text-align: center;"> <input type="button" value="Back"/> <span style="margin-left: 100px;"><input type="button" value="Next"/></span> </p> </div>	
Static IP address	Please enter the Static IP address

Subnet Mask	Please enter the Subnet Mask
IP Gateway	Please enter the IP Gateway
DNS Domain	Set the DNS domain suffix. When the user enter the domain name DNS address cannot be resolved, the domain equipment to resolve in the domain name.
Primary DNS	Please enter the Primary DNS server address
Secondary DNS	Please enter the Secondary DNS server address

Field Name	Explanation
------------	-------------

**Quick SIP Settings**

Display Name	The name shown in caller ID
Server Address	SIP server address either IP address or URI
Server Port	SIP server port (usually 5060)
User	Login name or Authentication ID.
Password	SIP password
SIP User	Phone number
Enable Registration	Submits registration information. Normally checked

**Displays detailed information for manual configuration.**

**After selecting DHCP and clicking NEXT, the Quick SIP Settings screen will appear. Click Back to return to the Wizard screen. Click Next to go to the Summary screen.**

**If PPPoE is selected, this screen will appear. Enter the information provided by the ISP. Click Next to go to Quick SIP Setting. Click Back to return to the Wizard screen.**

Click Finish button to save settings and reboot. After the reboot, SIP calls can be made.

**c) CALL LOG**

Outgoing call logs can be seen on this page

Start Time	Duration	Peer Calls	Type
February 26 14:01	7 second(s)	172.18.2.40@172.18.2.40	Received
February 26 14:00	10 second(s)	8207@1	Received

Call log	
Field Name	Explanation
Start time	Start time of the outgoing call
Duration	Duration of the outgoing call
Dialed calls	Account, protocol, and line of the outgoing call
Type	The call records of type

**d) LANGUAGE**

Set the current language.

e) TIME&DATE

STATUS
WIZARD
CALL LOG
LANGUAGE
TIME&DATE

> BASIC
> NETWORK
> VoIP
> INTERCOM
> SAFEGUARDING
> MAINTENANCE
> LOGOUT

**System Current Time**

2016/02/26 16:53:43

---

**Simple Network Time Protocol (SNTP) Settings**

Enable SNTP

Enable DHCP Time

Primary Server

Secondary Server

Timezone

Resync Period  second(s)

12-Hour Clock

---

**Daylight Saving Time Settings**

Enable

Offset  minutes(s)

Month

Week

Day

Hour

Minute

---

**Manual Time Settings**

Year

Month

Day

Hour

Minute

TIME&DATE	
Field Name	Explanation
<b>System Current Time</b>	
Display the current time	
<b>SNTP Settings</b>	
Enable SNTP	Enable or Disable SNTP
DHCP Time	If this is enabled, equipment will synchronize time with DHCP server
Primary Server	IP address of Primary SNTP Server



Secondary Server	IP address of Secondary SNTP Server
Time zone	Local Time Zone
Resync Period	Time between resync to SNTP server. Default is 60 seconds.
12-Hour Clock	If checked, clock is 12 hour mode. If unchecked, 24 hour mode. Default is 24 hour mode.
Date Format	Specify the date format. Fourteen different formats are available.

Field Name	Explanation
<b>Daylight Saving Time Settings</b>	
Enable	Enable daylight saving time
Offset(minutes)	DST offset. Default is 60 minutes
Month	Start and end month for DST
Week	Start and end week for DST
Day	Start and end day for DST
Hour	Start and end hour for DST
Minute	Start and end minute for DST
<b>Manual Time Settings</b>	
Enter the values for the current year, month, day, hour and minute. All values are required. Be sure to disable SNTP service before entering manual time and date.	

## (2) NETWORK

### a) WAN

The screenshot displays the WAN configuration interface. At the top, there are tabs for WAN, LAN, QoS/VLAN, WEB FILTER, FIREWALL, VPN, and SECURITY. The left sidebar contains navigation options: BASIC, NETWORK (selected), VoIP, INTERCOM, SAFEGUARDING, MAINTENANCE, and LOGOUT.

**WAN Status**

Active IP Address	172.18.2.112
Current Subnet Mask	255.255.0.0
Current IP Gateway	172.18.1.1
MAC Address	00:d8:4a:00:02:ba
MAC Timestamp	20150428

**WAN Settings**

Obtain DNS Server Automatically:

Static IP:  DHCP:  PPPoE:

**802.1X Settings**

User:

Password:

Enable 802.1X:

> MAINTENANCE  
> LOGOUT

**Service Port Settings** ⓘ

Web Server Type	<input type="text" value="HTTP"/>
HTTP Port	<input type="text" value="80"/>
HTTPS Port	<input type="text" value="443"/>
Telnet Port	<input type="text" value="23"/>
RTP Port Range Start	<input type="text" value="10000"/>
RTP Port Quantity	<input type="text" value="200"/>

<b>WAN</b>									
Field Name	Explanation								
<div style="background-color: #e6f2ff; padding: 10px;"> <p><b>WAN Status</b></p> <table style="width: 100%; border-collapse: collapse;"> <tr> <td style="width: 30%;">Active IP Address</td> <td>172.18.2.193</td> </tr> <tr> <td>Current Subnet Mask</td> <td>255.255.0.0</td> </tr> <tr> <td>Current IP Gateway</td> <td>172.18.1.1</td> </tr> <tr> <td>MAC Address</td> <td>0c:38:3e:13:3b:90</td> </tr> </table> </div>		Active IP Address	172.18.2.193	Current Subnet Mask	255.255.0.0	Current IP Gateway	172.18.1.1	MAC Address	0c:38:3e:13:3b:90
Active IP Address	172.18.2.193								
Current Subnet Mask	255.255.0.0								
Current IP Gateway	172.18.1.1								
MAC Address	0c:38:3e:13:3b:90								
Active IP address	The current IP address of the equipment								
Current subnet mask	The current Subnet Mask								
Current IP gateway	The current Gateway IP address								
MAC address	The MAC address of the equipment								
MAC Timestamp	Get the MAC address of time.								
<div style="background-color: #e6f2ff; padding: 10px;"> <p><b>WAN Settings</b></p> <table style="width: 100%; border-collapse: collapse;"> <tr> <td style="width: 40%;">Obtain DNS Server Automatically</td> <td><input type="text" value="Enabled"/></td> </tr> <tr> <td>Static IP <input type="radio"/></td> <td>                     DHCP <input checked="" type="radio"/> <span style="float: right;">PPPoE <input type="radio"/></span> </td> </tr> </table> <p style="text-align: right; margin-top: 10px;"><input type="button" value="Apply"/></p> </div>		Obtain DNS Server Automatically	<input type="text" value="Enabled"/>	Static IP <input type="radio"/>	DHCP <input checked="" type="radio"/> <span style="float: right;">PPPoE <input type="radio"/></span>				
Obtain DNS Server Automatically	<input type="text" value="Enabled"/>								
Static IP <input type="radio"/>	DHCP <input checked="" type="radio"/> <span style="float: right;">PPPoE <input type="radio"/></span>								
<p>Select the appropriate network mode. The equipment supports three network modes:</p>									
Static	Network parameters must be entered manually and will not change. All parameters are provided by the ISP.								
DHCP	Network parameters are provided automatically by a DHCP server.								
PPPoE	Account and Password must be input manually. These are provided by your ISP.								
<p><b>If Static IP is chosen, the screen below will appear. Enter values provided by the ISP.</b></p>									

IP Address	<input type="text" value="192.168.1.179"/>
Subnet Mask	<input type="text" value="255.255.255.0"/>
IP Gateway	<input type="text" value="192.168.1.1"/>
DNS Domain	<input type="text"/>
Primary DNS	<input type="text" value="202.96.134.133"/>
Secondary DNS	<input type="text" value="202.96.128.68"/>

Static IP address	Please enter the Static IP address
Subnet mask	Please enter the Subnet Mask
Gateway	Please enter the IP Gateway
DNS Domain	Set the DNS domain suffix. When the user enter the domain name DNS address cannot be resolved, the domain equipment to resolve in the domain name.
Primary DNS	Please enter the Primary DNS server address
Secondary DNS	Please enter the Secondary DNS server address

Field Name	Explanation
------------	-------------

**If PPPoE is chosen, the screen below will appear. Enter values provided by the ISP.**

Service Name	<input type="text" value="admin"/>
User	<input type="text" value="user123"/>
Password	<input type="password" value="*****"/>

Service Name	PPPoE Service name, Usually the default value.
User	ADSL user account
Password	ADSL password

After entering the new settings, click the APPLY button. The equipment will save the new settings and apply them. If a new IP address was entered for the equipment, it must be used to login to the phone after clicking the APPLY button.

<b>802.1X Settings</b>	
User	<input type="text" value="admin"/>
Password	<input type="password" value="*****"/>
Enable 802.1X	<input type="checkbox"/>

User	802.1X user account
Password	802.1X password
Enable 812.1X	Open/Close 812.1X

**Service Port Settings**

Web Server type	Specify Web Server Type – HTTP or HTTPS
HTTP port	Port for web browser access. Default value is 80. To enhance security, change this from the default. Setting this port to 0 will disable HTTP access. Example: The IP address is 192.168.1.70 and the port value is 8090, the accessing address is http://192.168.1.70:8090.
HTTPS port	Port for HTTPS access. Before using https, an https authentication certification must be downloaded into the equipment.

	Default value is 443. To enhance security, change this from the default.
Telnet port	Port for Telnet access. The default is 23.
RTP port range start	Set the beginning value for RTP Ports. Ports are dynamically allocated.
RTP port quantity	Set the maximum quantity of RTP Ports. The default is 200.

Note:

- 1) Any changes made on this page require a reboot to become active.
- 2) It is suggested that changes to HTTP Port and Telnet ports be values greater than 1024. Values less than 1024 are reserved.
- 3) If the HTTP port is set to 0, HTTP service will be disabled.

**b) LAN**

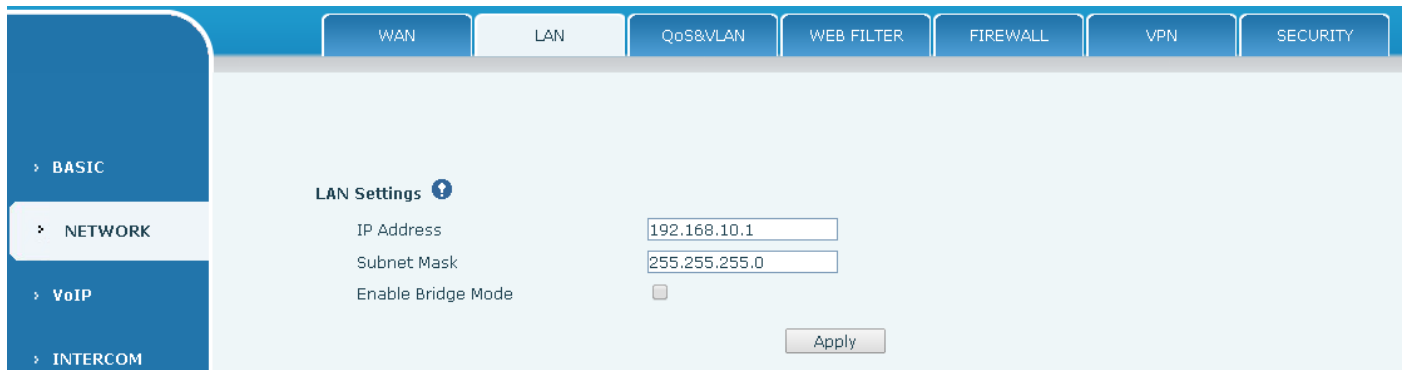

LAN	
Field Name	Explanation
IP address	LAN static IP
Subnet mask	LAN Subnet Mask
Enable bridge mode	If Bridge Mode is activated, the equipment will not provide an IP address for the LAN port. Instead, the LAN and WAN will be part of the same network. If this is activated, clicking Apply, will cause the equipment will reboot.
Note: If bridge mode is chosen, static LAN configuration will be disabled automatically.	

**c) QoS&VLAN**

The equipment supports 802.1Q/P protocol and DiffServ configuration. Use of a Virtual LAN (VLAN) allows voice and data traffic to be separated.

- Chart 1 shows a network switch with no VLAN. Any broadcast frames will be transmitted to all other ports. For example, and frames broadcast from Port 1 will be sent to Ports 2, 3, and 4.

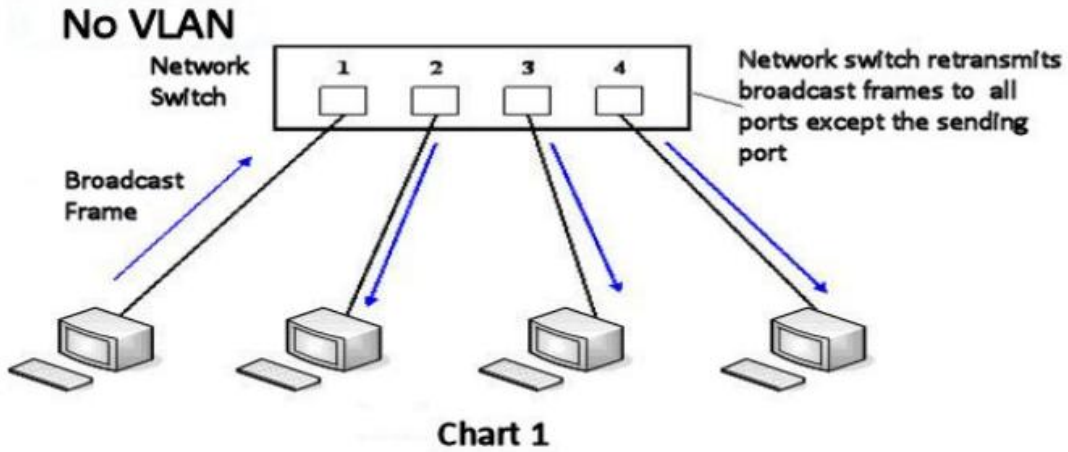

- Chart 2 shows an example with two VLANs indicated by red and blue. In this example, frames broadcast from Port 1 will only go to Port 2 since Ports 3 and 4 are in a different VLAN. VLANs can be used to divide a network by restricting the transmission of broadcast frames.

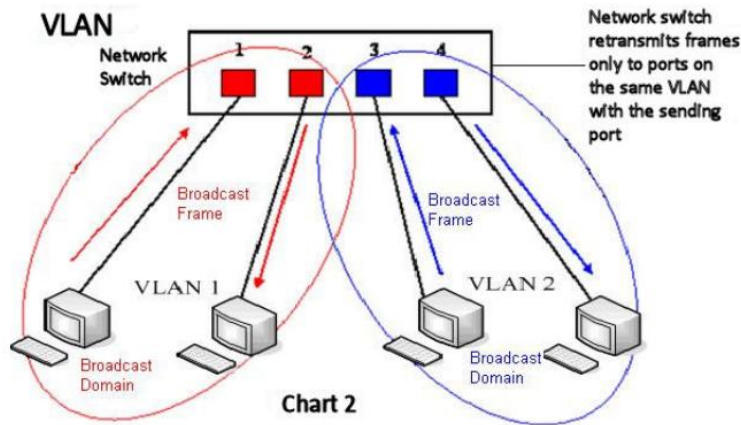

Note: In practice, VLANs are distinguished by the use of VLAN IDs.

WAN
LAN
QoS&VLAN
WEB FILTER
FIREWALL
VPN
SECURITY

- > BASIC
- > NETWORK
- > VoIP
- > INTERCOM
- > SAFEGUARDING
- > MAINTENANCE
- > LOGOUT

### Link Layer Discovery Protocol (LLDP) Settings

Enable LLDP  Packet Interval  (1~3600)second(s)

Enable Learning Function

---

### Quality of Service (QoS) Settings

Enable DSCP  SIP DSCP  (0~63)

Audio RTP DSCP  (0~63)

---

### WAN Port VLAN Settings

Enable WAN Port VLAN  WAN Port VLAN ID  (0~4095)

SIP 802.1P Priority  (0~7) Audio 802.1P Priority  (0~7)

---

### LAN Port VLAN Settings

LAN Port VLAN Mode  LAN Port VLAN ID  (0~4095)

QoS&VLAN	
Field Name	Explanation
<b>LLDP Settings</b>	
Enable LLDP	Enable or Disable Link Layer Discovery Protocol (LLDP)
Packet Interval	The time interval for sending LLDP Packets
Enable Learning Function	Enables the telephone to synchronize its VLAN data with the Network Switch. The telephone will automatically synchronize DSCP, 802.1p, and VLAN ID values even if these values differ from those provided by the LLDP server.
<b>QOS Settings</b>	
Enable DSCP	Enable or Disable Differentiated Services Code Point (DSCP)
SIP DSCP	Specify the value of the SIP DSCP in decimal
Audio RTP DSCP	Specify the value of the Audio DSCP in decimal
Field Name	Explanation
<b>WAN Port VLAN Settings</b>	
Enable WAN Port VLAN	Enable or Disable WAN Port VLAN
WAN Port VLAN ID	Specify the value of the WAN Port VLAN ID. Range is 0-4095
SIP 802.1P Priority	Specify the value of the signal 802.1p priority. Range is 0-7
Audio 802.1P Priority	Specify the value of the voice 802.1p priority. Range is 0-7
<b>LAN Port VLAN Settings</b>	
LAN Port VLAN	Follow WAN: LAN Port ID is same as WAN ID. Disable: Disable Port VALN Enable: Specify a VLAN ID for the LAN port which is different from WAN ID
LAN Port VLAN ID	Used when the VLAN ID is different from WAN ID. Range is 0-4095

### d) WEB FILTER

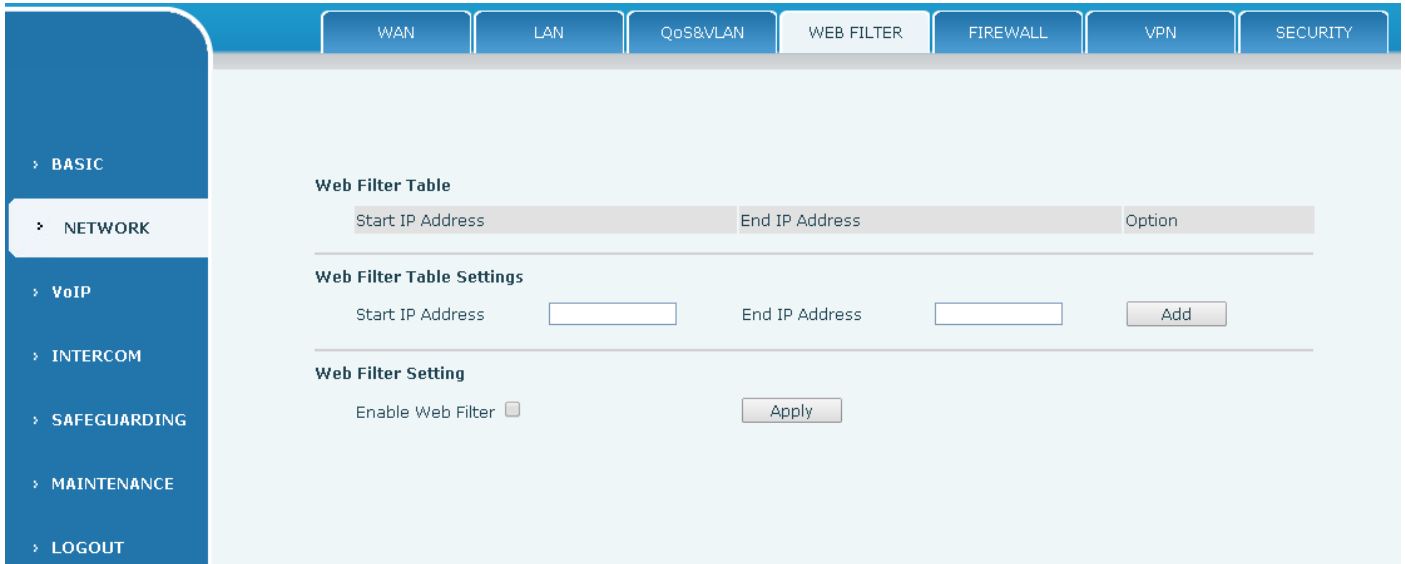

<b>Web filter</b>	
The Web filter is used to limit access to the equipment. When the web filter is enabled, only the IP addresses between the start IP and end IP can access the equipment.	
<b>Field Name</b>	<b>Explanation</b>
<b>Web Filter Table</b>	
Webpage access allows display the IP network list;	
<b>Web Filter Table Settings</b>	
Beginning and Ending IP Address for MMI Filter, Click add this filter range to the Web Filter Table	
<b>Web Filter Setting</b>	
Select to enable MMI Filter. Click [apply] Make filter settings effective.	

### e) FIREWALL

WAN
LAN
QoS&VLAN
WEB FILTER
FIREWALL
VPN
SECURITY

- > BASIC
- > NETWORK
- > VoIP
- > INTERCOM
- > SAFEGUARDING
- > MAINTENANCE
- > LOGOUT

**Firewall Type**

Enable Input Rules 
Enable Output Rules

---

**Firewall Input Rule Table**

Index	Deny/Permit	Protocol	Src Address	Src Mask	Dest Address	Dest Mask	Range	Port

---

**Firewall Output Rule Table**

Index	Deny/Permit	Protocol	Src Address	Src Mask	Dest Address	Dest Mask	Range	Port

---

**Firewall Settings**

Input/Output	<input type="text" value="Input"/>	Src Address	<input type="text"/>	
Deny/Permit	<input type="text" value="Deny"/>	Dest Address	<input type="text"/>	<input type="button" value="Add"/>
Protocol	<input type="text" value="UDP"/>	Src Mask	<input type="text"/>	
Port Range	<input type="text" value="more than"/> <input type="text"/>	Dest Mask	<input type="text"/>	

---

**Rule Delete Option**

Input/Output	<input type="text" value="Input"/>	Index To Be Deleted	<input type="text"/>	<input type="button" value="Delete"/>
--------------	------------------------------------	---------------------	----------------------	---------------------------------------

**Firewall**

Firewall rules can be used to prevent unauthorized Internet users from accessing private networks connected to this phone (input rule), or prevent unauthorized devices connected to this phone from accessing the Internet (output rule). Each rule type supports a maximum of 10 items.

Field Name	Explanation
<b>Firewall Rules Settings</b>	
Enable Input Rules	Enable rules limiting access from the Internet.
Enable Output Rules	Enable rules limiting access to the Internet.
<b>Firewall Settings</b>	
Input / Output	Specify if the current rule is input or output.
Deny/Permit	Specify if the current rule is Deny or Permit.
Protocol type	Filter protocol type (TCP/ UDP/ ICMP/ IP)
Port Range	Set the filter Port range
Source Address	Set source address. It can be a single IP address or use * as a wild card. For example: 192.168.1.14 or *.*.*.14.
Destination Address	Set destination address. It can be a single IP address or use * as a wild card. For example: 192.168.1.14 or *.*.*.14.
Source Mask	Set the source address mask. For example: 255.255.255.255 points to one host while 255.255.255.0 points to a C type network.
Destination Mask	Set the destination address mask. For example: 255.255.255.255 points to one host while 255.255.255.0 points to a C type network.

**f) VPN**



The device supports remote connection via VPN. It supports both Layer 2 Tunneling Protocol (L2TP) and OpenVPN protocol. This allows users at remote locations on the public network to make secure connections to local networks.

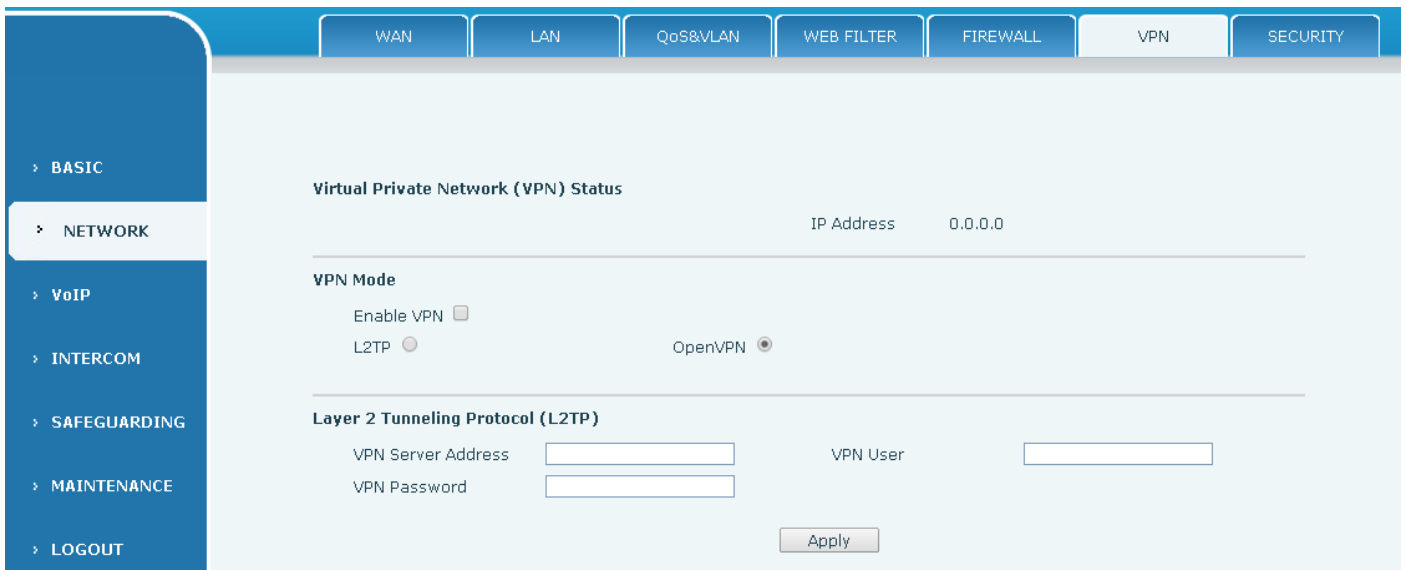
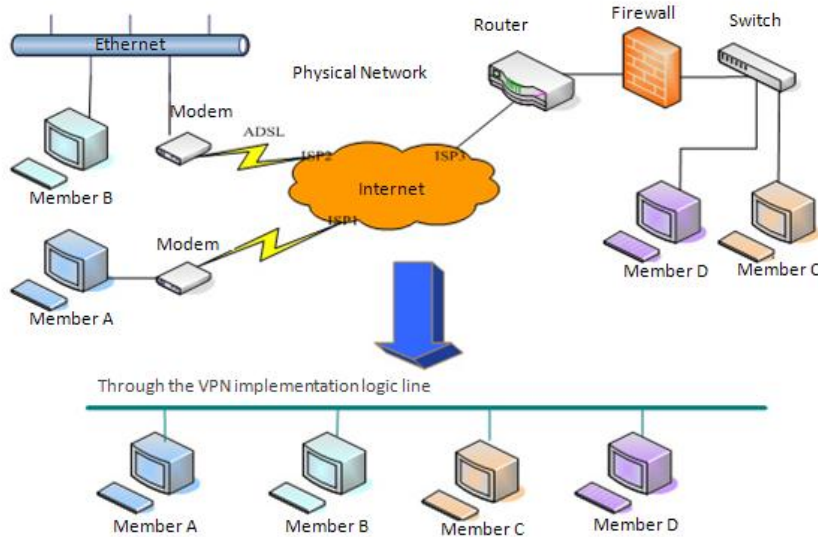

Field Name	Explanation
IP Address	Shows the current VPN IP address.
<b>VPN Mode</b>	
Enable VPN	Enable/Disable VPN.
L2TP	Select Layer 2 Tunneling Protocol
OpenVPN	Select OpenVPN Protocol. (Only one protocol may be activated. After the selection is made, the configuration should be saved and the phone rebooted.)
<b>L2TP</b>	
VPN Server address	Set VPN L2TP Server IP address.
VPN user	Set User Name access to VPN L2TP Server.
VPN password	Set Password access to VPN L2TP Server.

## g) SECURITY

Field Name	Explanation
<b>Update Security File</b>	Select the security file to be updated. Click the Update button to update.
<b>Delete Security File</b>	Select the security file to be deleted. Click the Delete button to Delete.
<b>SIP TLS Files</b>	Show SIP TLS authentication certificate.
<b>HTTPS Files</b>	Show HTTPS authentication certificate.
<b>OpenVPN Files</b>	Show OpenVPN File authentication certificate file.

## (3) VOIP

### a) SIP

Configure a SIP server on this page.

**Advanced SIP Settings >>**

Proxy Server Address	<input type="text"/>	Proxy Server Port	<input type="text"/>
Proxy User	<input type="text"/>	Proxy Password	<input type="text"/>
Backup Server Address	<input type="text"/>	Backup Server Port	<input type="text" value="5060"/>
Domain Realm	<input type="text"/>	Server Name	<input type="text"/>
RTP Encryption	<input type="checkbox"/>	Enable Session Timer	<input type="checkbox"/>
Registration Expires	<input type="text" value="60"/> second(s)	Session Timeout	<input type="text" value="0"/> second(s)
Keep Alive Type	<input type="text" value="SIP Option"/>	Keep Alive Interval	<input type="text" value="60"/> second(s)
User Agent	<input type="text"/>	Server Type	<input type="text" value="COMMON"/>
DTMF Type	<input type="text" value="AUTO"/>	RFC Protocol Edition	<input type="text" value="RFC3261"/>
DTMF SIP INFO Mode	<input type="text" value="Send */#"/>	Local Port	<input type="text" value="5060"/>
Enable Rport	<input type="checkbox"/>	Keep Authentication	<input type="checkbox"/>
Enable PRACK	<input type="checkbox"/>	Ans. With a Single Codec	<input type="checkbox"/>
Enable Strict Proxy	<input type="checkbox"/>	Auto TCP	<input type="checkbox"/>
Enable DNS SRV	<input type="checkbox"/>	Use VPN	<input checked="" type="checkbox"/>
Transport Protocol	<input type="text" value="UDP"/>		

**SIP Global Settings >>**

Strict Branch	<input type="checkbox"/>	Enable Group	<input type="checkbox"/>
Registration Failure Retry Time	<input type="text" value="32"/> second(s)	DND Return Code	<input type="text" value="480(Temporarily Not Available)"/>
Reject Return Code	<input type="text" value="603(Decline)"/>	Busy Return Code	<input type="text" value="486(Busy Here)"/>

SIP	
Field Name	Explanation
<b>Basic Settings</b> (Choose the SIP line to configured)	
Status	Shows registration status. If the registration is successful will display has been registered, not successful display not registered, the wrong password is displayed 403 errors, account number failure display timeout.
Server address	SIP server IP address or URI.
Server port	SIP server port. Default is 5060.
Authentication User	SIP account name (Login ID).
Authentication password	SIP registration password.
SIP user	Phone number assigned by VoIP service provider. Equipment will not register if there is no phone number configured.
Display name	Set the display name. This name is shown on Caller ID.

Field Name	Explanation
<b>Advanced SIP Settings</b>	
Proxy server address	SIP proxy server IP address or URI, (This is normally the same as the SIP Registrar Server)
Proxy server port	SIP Proxy server port. Normally 5060.
Proxy user	SIP Proxy server account.
Proxy password	SIP Proxy server password.
Backup Proxy server address	Backup SIP Server Address or URI (This server will be used if the primary server is unavailable)
Backup Proxy server port	Backup SIP Server Port
Domain Realm	SIP Domain if different than the SIP Register Server.
Server name	Name of SIP Backup server
RTP Encryption	Enable/Disable RTP Encryption.
Enable Session Timer	If enabled, this will refresh the SIP session timer per RFC4028.
Registration Expires	SIP re-registration time. Default is 60 seconds. If the server requests a different time, the phone will change to that value.
Session Timeout	Refresh interval if Session Timer is enabled.
Keep Alive Type	Specifies the NAT keep alive type. If SIP Option is selected, the equipment will send SIP Option sip messages to the server every NAT Keep Alive Period. The server will then respond with 200 OK. If UDP is selected, the equipment will send a UDP message to the server every NAT Keep Alive Period.
Keep Alive Interval	Set the NAT Keep Alive interval. Default is 60 seconds
User Agent	Set SIP User Agent value.
Server Type	Configures phone for unique requirements of selected server.
DTMF Type	DTMF sending mode. There are four modes: <ul style="list-style-type: none"> <li>● In-band</li> <li>● RFC2833</li> <li>● SIP_INFO</li> <li>● AUTO</li> </ul> Different VoIP Service providers may require different modes.
RFC Protocol Edition	Select SIP protocol version RFC3261 or RFC2543. Default is RFC3261. Used for servers which only support RFC2543.
DTMF SIP INFO Mode	You can chose Send 10/11 or Send */#
Local Port	SIP port. Default is 5060.
Enable Rport	Enable/Disable support for NAT traversal via RFC3581 (Rport).

Field Name	Explanation
Keep Authentication	Enable /disable registration with authentication. It will use the last authentication field which passed authentication by server. This will decrease the load on the server if enabled
Enable PRACK	Enable or disable SIP PRACK function. Default is OFF. It is suggested this be used.
Ans. With a Single Codec	If enabled phone will respond to incoming calls with only one codec.
Enable Strict Proxy	Enables the use of strict routing. When the phone receives packets from the server it will use the source IP address, not the address in via field.
Auto TCP	Force the use of TCP protocol to guarantee usability of transport for SIP messages above 1500 bytes
Enable DNS SRV	Enables use of DNS SRV records
Use VPN	Enable SIP use VPN for every line individually, not all of them
Transport Protocol	Configuration using the transport protocol, TCP, TLS or UDP, the default is UDP.
<b>SIP Global Settings</b>	
Strict Branch	Enable Strict Branch - The value of the branch must be after "z9hG4bK" in the VIA field of the INVITE message received, or the phone will not respond to the INVITE. Note: This will affect all lines
Enable Group	Enable SIP Group Backup. This will affect all lines
Registration Failure Retry Time	Registration failures retry time – If registrations fails, the phone will attempt to register again after registration failure retry time. This will affect all lines
DND Return Code	Specify SIP Code returned for DND. Default is 480 - Temporarily Not Available.
Reject Return Code	Specify SIP Code returned for Rejected call. Default is 603 – Decline.
Busy Return Code	Specify SIP Code returned for Busy. Default is 486 – Busy Here.

**b) STUN**

STUN – Simple Traversal of UDP through NAT –A STUN server allows a phone in a private network to know its public IP and port as well as the type of NAT being used. The equipment can then use this information to register itself to a SIP server so that it can make and receive calls while in a private network.

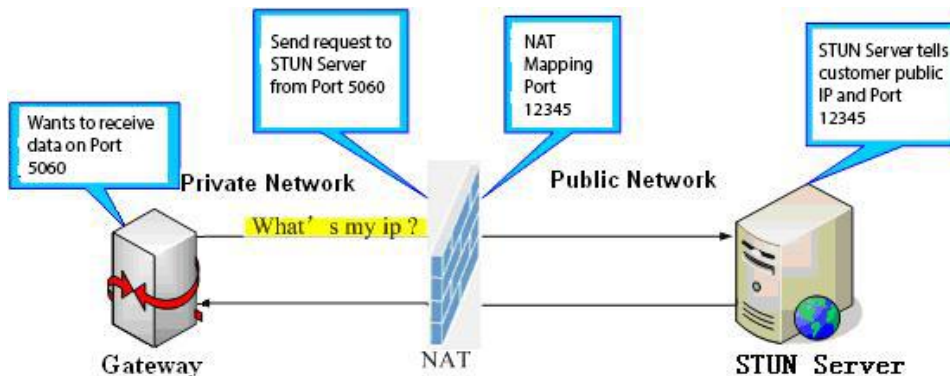

\*
\*

SIP

STUN

- > BASIC
- > NETWORK
- > VoIP
- > INTERCOM
- > SAFEGUARDING
- > MAINTENANCE
- > LOGOUT

### Simple Traversal of UDP through NATs (STUN) Settings

STUN NAT Traversal FALSE

Server Address

Server Port

Binding Period  second(s)

SIP Waiting Time  millisecond(s)

Local SIP Port

---

#### SIP Line Using STUN

▼

Use STUN

<b>STUN</b>	
Field Name	Explanation
STUN NAT Traversal	Shows whether or not STUN NAT Traversal was successful.
Server Address	STUN Server IP address
Server Port	STUN Server Port – Default is 3478.
Binding Period	STUN blinding period – STUN packets are sent at this interval to keep the NAT mapping active.
SIP Waiting Time	Waiting time for SIP. This will vary depending on the network.
Local SIP Port	Port configure the local SIP signaling
<b>SIP Line Using STUN (SIP1 or SIP2)</b>	
Use STUN	Enable/Disable STUN on the selected line.
Note: the SIP STUN is used to achieve the SIP penetration of NAT, is the realization of a service, when the equipment configuration of the STUN server IP and port (usually the default is 3478), and select the Use Stun SIP server, the use of NAT equipment to achieve penetration.	

## (4) Intercom

### a) FUNCTION KEY

#### ➤ Key Event Settings

Set the key type to the Key Event.

DSS key type	Subtype	Usage
Key Event	None	Not responding
	Dial	Dial function
	Release	End calls
	OK	Identify key
	Handfree	The hand-free key(with hook dial, hang up)

#### ➤ Hot key Settings

Enter the phone number in the input box, when you press the shortcut key, equipment will dial set telephone number. This button can also be used to set the IP address, press the shortcut key IP direct dial call.

DSS	Number	Line	Subtype	Usage
-----	--------	------	---------	-------

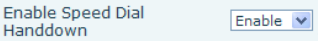
key type				
Hot Key	Fill the called party's SIP account or address	The SIP account corresponding lines	Speed Dial	In Speed dial mode, with  can define whether this call is allowed to be hang up by re-press the speed dial
			Intercom	In Intercom mode, if the caller's IP phone support intercom feature, can realize auto answer

➤ **Multicast Settings**

Multicast function is launched will voice messages sent to set the multicast address, all equipment to monitor the group multicast address can receive sponsors speech information, etc. Using multicast functionality can be simple and convenient to send notice to each member in the multicast.

Through the DSS Key configuration multicast calling WEB is as follows:

Key	Type	Number 1	Number 2	Line	Subtype
DSS Key 1	Multicast			SIP1	G.711A
DSS Key 2	None			SIP1	G.711A
DSS Key 3	Hot Key			SIP1	G.711U
DSS Key 4	Line			SIP1	G.722
	Key Event			SIP1	G.723.1
	Multicast			SIP1	G.726-32
	None			SIP1	G.729AB

DSS key type	Number	Subtype	Usage
Multicast	Set the host IP address and port number, the middle separated by a colon	G.711A	Narrowband speech coding (4Khz)
		G.711U	
		G.722	Wideband speech coding (7Khz)
		G.723.1	Narrowband speech coding (4Khz)
		G.726-32	
		G.729AB	

✧ operation mechanism

Device through the DSS Key configuration of multicast address and port and started coding; set by WEB to monitor the multicast address and port; device sends a multicast, listens to the address of the device can receive the multicast content.

✧ calling configuration

The call is already exists, and three party or initiated multicast communication, so it will not be able to launch a new multicast call.



**b) AUDIO**

This page configures audio parameters such as voice codec; speak volume, MIC volume and ringer volume.

Field Name	Explanation
<b>Audio Settings</b>	
First Codec	The first codec choice: G.711A/U, G.722, G.723.1, G.726-32, G.729AB
Second Codec	The second codec choice: G.711A/U, G.722, G.723.1, G.726-32, G.729AB, None
Third Codec	The third codec choice: G.711A/U, G.722, G.723.1, G.726-32, G.729AB, None
Fourth Codec	The forth codec choice: G.711A/U, G.722, G.723.1, G.726-32, G.729AB, None
DTMF Payload Type	The RTP Payload type that indicates DTMF. Default is 101
Default Ring Type	Ring Sound – There are 9 standard types and 3 User types.
G.729AB Payload Length	G.729AB Payload Length – Adjusts from 10 – 60 mSec.
Tone Standard	Configure tone standard area.
G.722 Timestamps	Choices are 160/20ms or 320/20ms.
G.723.1 Bit Rate	Choices are 5.3kb/s or 6.3kb/s.
Enable VAD	Enable or disable Voice Activity Detection (VAD). If VAD is enabled, G729 Payload length cannot be set greater than 20 mSec.

Field Name	Explanation
<b>Talk Volume Settings</b>	
SPK Output Volume	Set the speaker calls the volume level.
MIC Input Volume	Set the MIC calls the volume level.
<b>Media Volume Settings</b>	
Broadcast Output Volume	Set the broadcast the output volume level.
Signal Tone Volume	Set the audio signal the output volume level.
<b>Codec Gain Settings</b>	
Hands-free Hardware MIC Gain	Settings Hands-free Hardware MIC Gain
Hands-free Hardware Speakerphone Gain	Settings hands-free Hardware Speakerphone Gain

**c) FEATURE**

The screenshot displays the configuration interface for the SIP Intercom System. The top navigation bar includes tabs for FUNCTION KEY, AUDIO, FEATURE (selected), MCAST, and Action URL. A left sidebar lists menu items: BASIC, NETWORK, VoIP, INTERCOM (selected), SAFEGUARDING, MAINTENANCE, and LOGOUT. The main content area is titled 'Feature Settings' and contains various configuration options:

- DND (Do Not Disturb):
- Enable Intercom Mute:
- Enable Auto Answer: Lines and IP Call (dropdown)
- No Answer Handdown:
- Dial Fixed Length to Send:
- Enable Speed Dial Handdown: Enable (dropdown)
- Use Function Key to Answer: Disable (dropdown)
- Hot Key Dial Mode Select: Main-Secondary (dropdown)
- Day Start Time: 06:00 (00:00~23:59)
- Description: IP Intercom
- Ban Outgoing:
- Enable Intercom Tone:
- Auto Answer Timeout: 0 (0~60s)
- No Ans. Handdown Time: 30 (1~60s)
- Send length: 11
- Dial Number Voice Play: Disable (dropdown)
- Status Led Reuse Mode: Disable (dropdown)
- Call Switched Time: 16 (5~50s)
- Day End Time: 18:00 (00:00~23:59)

An 'Apply' button is located below the settings. Below the Feature Settings section is the 'Block Out Settings' section, which includes a 'Block Out' field, an 'Add' button, a dropdown arrow, and a 'Delete' button.

Field Name	Explanation
<b>Feature Settings</b>	
DND (Do Not Disturb)	DND might be disabled phone for all SIP lines, or line for SIP individually. But the outgoing calls will not be affected
Ban Outgoing	If enabled, no outgoing calls can be made.

Enable Intercom Mute	If enabled, mutes incoming calls during an intercom call.
<b>Field Name</b>	<b>Explanation</b>
Enable Intercom Tone	If enabled, plays intercom ring tone to alert to an intercom call.
Enable Auto Answer	Enable Auto Answer function
Auto Answer Timeout	Set Auto Answer Timeout
No Answer Handdown	Enable automatically hang up when no answer
No Answer Handdown Time	Configuration in a set time, automatically hang up when no answer
Dial Fixed Length to Send	Enable or disable dial fixed length to send.
Send length	The number will be sent to the server after the specified numbers of digits are dialed.
Enable Speed Dial Handdown	Enable Speed Dial Hand Up function
Dial Number Voice Play	Configuration Open / Close Dial Number Voice Play
Use Function Key to Answer	Configure whether to enable the function keys, is disabled by default.
Status Led Reuse Mode	Enable the function, the registered status indicator will reuse the call instructions function, which means the LED will flashes in the call state.
Hot Key Dialed Mode Selection	<p>&lt;Primary /Secondary&gt;mode allow system to call primary extension first, if there were no answer, it would cancel the call and then call secondary extension automatically.</p> <p>&lt;Day/Night&gt;mode allow system to check the calling time is belong to Day or Night time, and then decide to call the number 1 or number 2 automatically. Users just press speed dial key once.</p>
Call Switched Time	The period between hot key dialing to the first and second number.
Day Start Time	The start time of the Day When you select<Day/Night>mode
Day End Time	The end time of the day When you select <Day/Night>mode
Description	Device description displayed on IP scanning tool software.
<b>Block Out Settings</b>	
<p>Add or Delete Blocked numbers – Enter the prefix of numbers which should not be dialled by the phone. For example, if 001 is entered, the phone will not dial any numbers beginning with 001.</p> <p>X and x are wildcards which match single digits. For example, if 4xxx or 4XXX is entered, the phone will not dial any 4 digit numbers beginning with 4. It will dial numbers beginning with 4 which are longer or shorter than 4 digits.</p>	

### d) MCAST

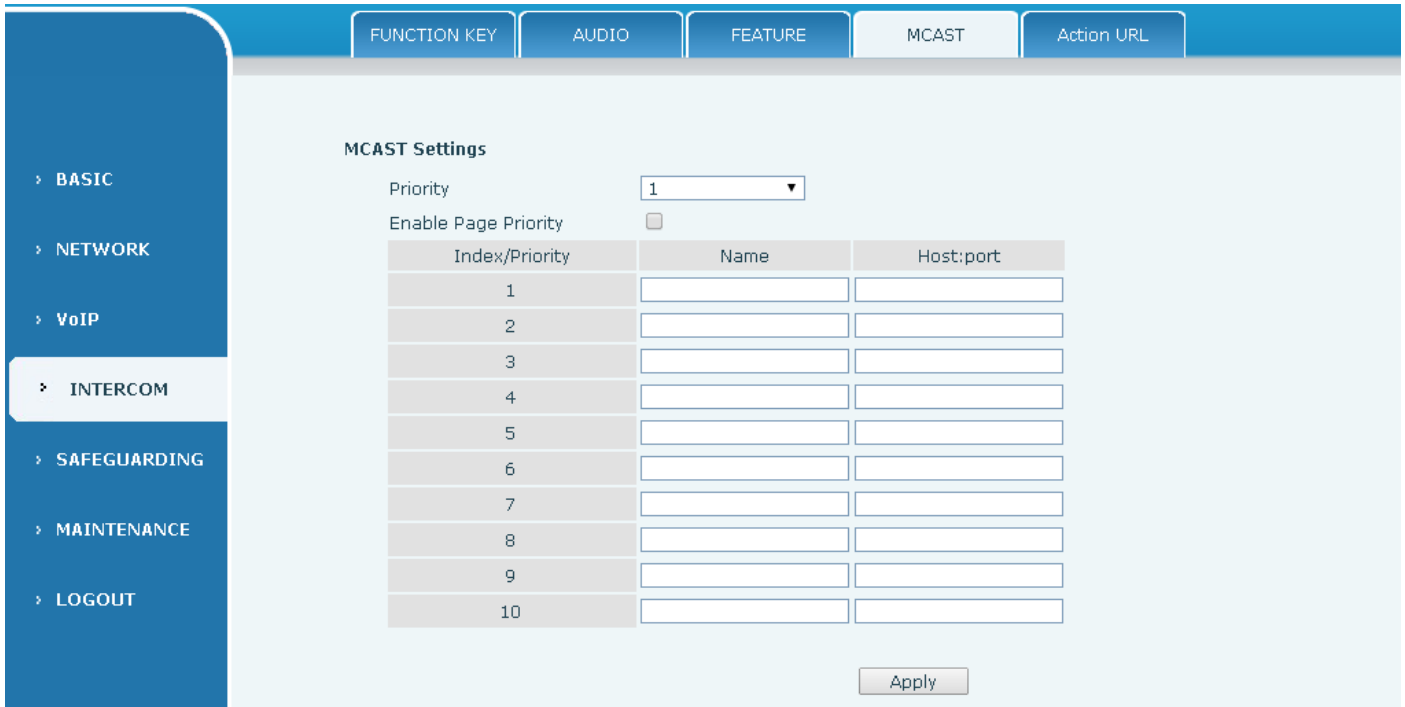

It is easy and convenient to use multicast function to send notice to each member of the multicast via setting the multicast key on the device and sending multicast RTP stream to pre-configured multicast address. By configuring monitoring multicast address on the device, monitor and play the RTP stream which sent by the multicast address.

#### MCAST Settings

Equipment can be set up to monitor up to 10 different multicast address, used to receive the multicast RTP stream sent by the multicast address.

Here are the ways to change equipment receiving multicast RTP stream processing mode in the Web interface: set the ordinary priority and enable page priority.

- Priority:

In the drop-down box to choose priority of ordinary calls the priority, if the priority of the incoming flows of multicast RTP, lower precedence than the current common calls, device will automatically ignore the group RTP stream. If the priority of the incoming flow of multicast RTP is higher than the current common calls priority, device will automatically receive the group RTP stream, and keep the current common calls in state. You can also choose to disable in the receiving threshold drop-down box, the device will automatically ignore all local network multicast RTP stream.

- The options are as follows:

- ✧ 1-10: To definite the priority of the common calls, 1 is the top level while 10 is the lowest
- ✧ Disable: ignore all incoming multicast RTP stream
- ✧ Enable the page priority:

Page priority determines the device how to deal with the new receiving multicast RTP stream when it is in multicast session currently. When Page priority switch is enabled, the device will automatically ignore the low priority multicast RTP stream but receive top-level priority multicast

RTP stream, and keep the current multicast session in state; If it is not enabled, the device will automatically ignore all receiving multicast RTP stream.

● **Web Settings:**

**MCAST Settings**

Priority

Enable Page Priority

Index/Priority	Name	Host:port
1	ss	239.1.1.1:1366
2	ee	239.1.1.1:1367

The multicast SS priority is higher than that of EE, which is the highest priority.

Note: when pressing the multicast key for multicast session, both multicast sender and receiver will beep.

**Listener configuration**

**MCAST Settings**

Priority

Enable Page Priority

Index/Priority	Name	Host:port
1	group 1	224.0.0.2:2366
2	group 2	224.0.0.2:1366
3	group 3	224.0.0.6:3366
4		
5		
6		
7		
8		
9		
10		

● **Blue part (name)**

"Group 1", "Group 2" and "Group 3" are your setting monitoring multicast name. The group name will be displayed on the screen when you answer the multicast. If you have not set, the screen will display the IP: port directly.

● **Purple part (host: port)**

It is a set of addresses and ports to listen, separated by a colon.

● **Pink part (index / priority)**

Multicast is a sign of listening, but also the monitoring multicast priority. The smaller number refers to higher priority.

● **Red part (priority)**

It is the general call, non multicast call priority. The smaller number refers to high priority. The followings will explain how to use this option:

- ✧ The purpose of setting monitoring multicast "Group 1" or "Group 2" or "Group 3" launched a multicast call.
- ✧ All equipment has one or more common non multicast communication.
- ✧ When you set the Priority for the disable, multicast any level will not answer, multicast call is rejected.
- ✧ when you set the Priority to a value, only higher than the priority of multicast can come in, if you set the Priority is 3, group 2 and group 3 for priority level equal to 3 and less than 3 were rejected, 1 priority is

2 higher than ordinary call priority device can answer the multicast message at the same time, keep the hold the other call.

● **Green part (Enable Page priority)**

Set whether to open more priority is the priority of multicast, multicast is pink part number. Explain how to use:

- ✧ The purpose of setting monitoring multicast "group 1" or "3" set up listening "group of 1" or "3" multicast address multicast call.
- ✧ All equipment has been a path or multi-path multicast phone, such as listening to "multicast information group 2".
- ✧ If multicast is a new "group of 1", because "the priority group 1" is 2, higher than the current call "priority group 2" 3, so multicast call will can come in.
- ✧ If multicast is a new "group of 3", because "the priority group 3" is 4, lower than the current call "priority group 2" 3, "1" will listen to the equipment and maintain the "group of 2".

**Multicast service**

- **Send:** when configured ok, our key press shell on the corresponding equipment, equipment directly into the Talking interface, the premise is to ensure no current multicast call and 3-way of the case, the multicast can be established.

**Lmonitor:** IP port and priority configuration monitoring device, when the call is initiated and incoming multicast, directly into the Talking interface equipment.

**e) Action URL**

FUNCTION KEY	AUDIO	FEATURE	MCAST	Action URL
<b>Action URL Settings</b>				
				Active URI Limit IP
				Setup Completed
				Registration Success
				Registration Disabled
				Registration Failed
				Off Hook
				On Hook
				Incoming Call
				Outgoing Call
				Call Established
				Call Terminated
				DND Enabled
				DND Disabled
				Mute
				Unmute
				Missed Call
				IP Changed
				Idle To Busy
				Busy To Idle
Apply				

**Action URL Settings**

URL for various actions performed by the phone. These actions are recorded and sent as xml files to the server. Sample format is http://InternalServer /FileName.xml

### (5) SAFEGUARDING

Security Settings	
Field Name	Explanation
<b>Input settings</b>	
Input 1	Open /Close Input port1
Trigger Mode	When choosing the low level trigger (closed trigger), detect the input port 1 (low level) closed trigger.
	When choosing the high level trigger (disconnected trigger), detect the input port 1 (high level) disconnected trigger.
Response Mode	Open /Close Input port1 the Remote Response
Input 2	Open /Close Input port2
Trigger Mode	When choosing the low level trigger (closed trigger), detect the input port 2 (low level) closed trigger.
	When choosing the high level trigger (disconnected trigger), detect the input port 2 (high level) disconnected trigger.

Response Mode	Open /Close Input port2 the Remote Response	
<b>Field Name</b>	<b>Explanation</b>	
<b>Output Settings</b>		
Output 1/2	Open/close, Output 1/Output 2	
Output Level	When choosing the low level trigger (NO: normally open), when meet the trigger condition, trigger the NO port disconnected.	
	When choosing the high level trigger (NO: normally close), when meet the trigger condition, trigger the NO port close.	
Output Duration	Changes in port, the duration of. The default is 5 seconds.	
Output Trigger Mode: There are many kinds of trigger modes, multiple choices.		
Input port1 trigger	When the input port1 meet to trigger condition, the output port1 will trigger(The Port level time change, By < Output Duration > control)	
Input port2 trigger	When the input port2 meet to trigger condition, the output port2 will trigger(The Port level time change, By < Output Duration > control)	
Remote DTMF trigger	By duration	Received the terminal equipment to send the DTMF password, if correct, which triggers the corresponding output port (The Port level time change, By < Output Duration > control)
	By Calling State	During the call, receive the terminal equipment to send the DTMF password, if correct, which triggers the corresponding output port (The Port level time change, (By call state control, after the end of the call, port to return the default state)
Remote SMS trigger	In the remote device or server to send instructions to ALERT=[instructions], if correct, which triggers the corresponding output port	
Call state trigger	The port output continuous time synchronization and trigger state changes, including the trigger conditions: 1, call; 2, call and singing; 3, singing; three models. (for example: the call trigger output port, will be in conversation state continued to output the corresponding level)	
Emergency key trigger	When the emergency call button to trigger the equipment shell, which triggers the corresponding output port(after the end of the call, port to return the default state)	
<b>Server &amp; Trigger Ring Type Settings</b>		
Server Address	Configure remote response server address(including remote response server address and tamper alarm server address)	
Input 1 trigger ring	When the input port 1 triggering condition is satisfied, the corresponding ring tone or alarm	
Input 2 trigger ring	When the input port 2 triggering condition is satisfied, the corresponding ring tone or alarm	
Remote DTMF trigger ring	When received the remote DTMF command, whether to output the ringtone	
Remote SMS trigger ring	When receiving the remote SMS instructions, whether to output the ringtone	
Alarm Ring Duration	duration of alarm ring(not including tamper alarm)	



**(6) MAINTENANCE**  
**a) AUTO PROVISION**

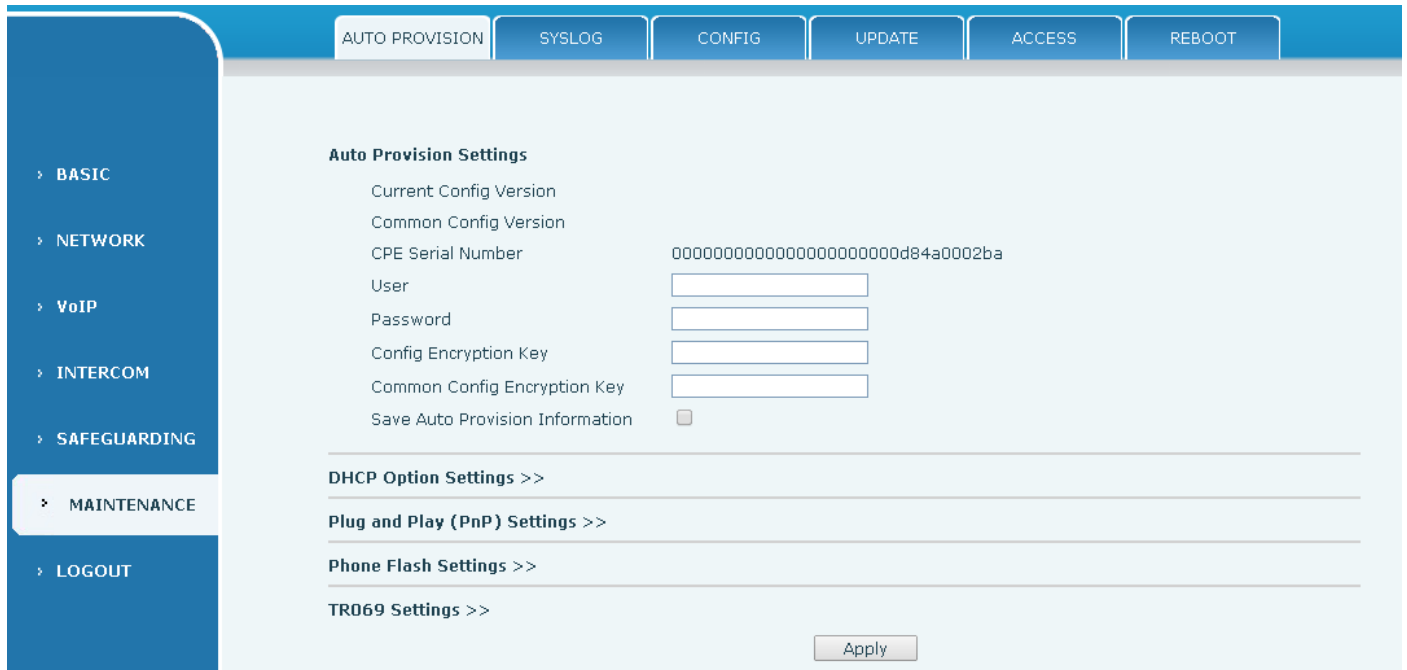

The equipment supports PnP, DHCP, and Phone Flash to obtain configuration parameters. They will be queried in the following order when the equipment boots.

DHCP option → PnP server → Phone Flash

Field Name	Explanation
<b>Auto Provision Settings</b>	
Current Config Version	Show the current config file’s version. If the version of configuration downloaded is higher than this, the configuration will be upgraded. If the endpoints confirm the configuration by the Digest method, the configuration will not be upgraded unless it differs from the current configuration
Common Config Version	Show the common config file’s version. If the configuration downloaded and this configuration is the same, the auto provision will stop. If the endpoints confirm the configuration by the Digest method, the configuration will not be upgraded unless it differs from the current configuration.
CPE Serial Number	Serial number of the equipment
User	Username for configuration server. Used for FTP/HTTP/HTTPS. If this is blank the phone will use anonymous
Password	Password for configuration server. Used for FTP/HTTP/HTTPS.
Config Encryption Key	Encryption key for the configuration file

Field Name	Explanation
------------	-------------

Common Config Encryption Key	Encryption key for common configuration file
Save Auto Provision Information	Save the auto provision username and password in the phone until the server url changes
<b>DHCP Option Settings</b>	
DHCP Option Setting	The equipment supports configuration from Option 43, Option 66, or a Custom DHCP option. It may also be disabled.
Custom DHCP Option	Custom option number. Must be from 128 to 254.
<b>Plug and Play(PnP)Settings</b>	
Enable PnP	If this is enabled, the equipment will send SIP SUBSCRIBE messages to a multicast address when it boots up. Any SIP server understanding that message will reply with a SIP NOTIFY message containing the Auto Provisioning Server URL where the phones can request their configuration.
PnP server	PnP Server Address
PnP port	PnP Server Port
PnP Transport	PnP Transfer protocol – UDP or TCP
PnP Interval	Interval time for querying PnP server. Default is 1 hour.
<b>Phone Flash Settings</b>	
Server Address	Set FTP/TFTP/HTTP server IP address for auto update. The address can be an IP address or Domain name with subdirectory.
Config File Name	Specify configuration file name. The equipment will use its MAC ID as the config file name if this is blank.
Protocol Type	Specify the Protocol type FTP, TFTP or HTTP.
Update Interval	Specify the update interval time. Default is 1 hour.
Update Mode	<ol style="list-style-type: none"> <li>1. Disable – no update</li> <li>2. Update after reboot – update only after reboot.</li> <li>3. Update at time interval – update at periodic update interval</li> </ol>
<b>TR069 Settings</b>	
Enable TR069	Enable/Disable TR069 configuration
Enable TR069 Warning Tone	Enable or disable TR069 Warning Tone
ACS Server Type	Select Common or CTC ACS Server Type.
ACS Server URL	ACS Server URL.
ACS User	User name for ACS.
ACS Password	ACS Password.
TR069 Auto	Enable/Disable TR069 Auto Login.

Login	
-------	--

## b) SYSLOG

Syslog is a protocol used to record log messages using a client/server mechanism. The Syslog server receives the messages from clients, and classifies them based on priority and type. Then these messages will be written into a log by rules which the administrator has configured.

There are 8 levels of debug information.

Level 0: emergency; System is unusable. This is the highest debug info level.

Level 1: alert; Action must be taken immediately.

Level 2: critical; System is probably working incorrectly.

Level 3: error; System may not work correctly.

Level 4: warning; System may work correctly but needs attention.

Level 5: notice; It is the normal but significant condition.

Level 6: Informational; It is the normal daily messages.

Level 7: debug; Debug messages normally used by system designer. This level can only be displayed via telnet.

Field Name	Explanation
<b>Syslog settings</b>	
Server Address	System log server IP address.
Server port	System log server port.
MGR log level	Set the level of MGR log.
SIP log level	Set the level of SIP log.
Enable syslog	Enable or disable system log.
<b>Web Capture</b>	
Start	Capture a packet stream from the equipment. This is normally used to troubleshoot problems.
Stop	Stop capturing the packet stream

c) CONFIG

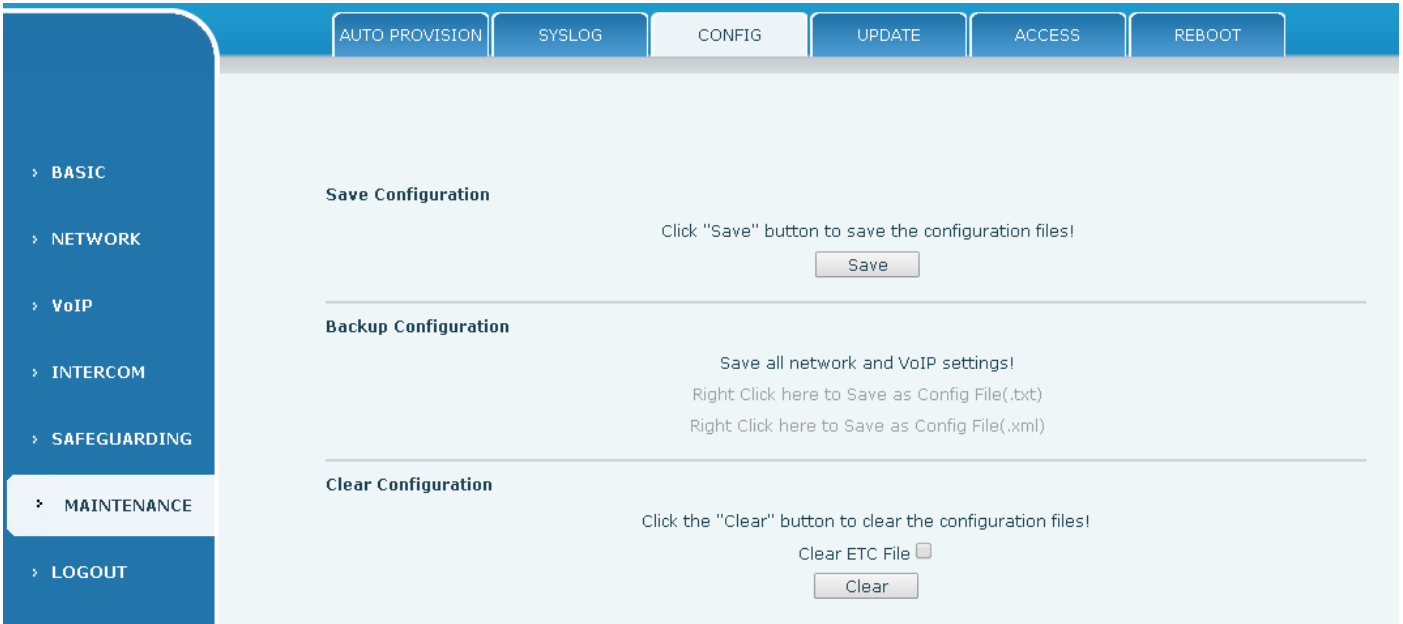

Field Name	Explanation
Save Configuration	Save the current equipment configuration. Clicking this saves all configuration changes and makes them effective immediately.
Backup Configuration	Save the equipment configuration to a txt or xml file. Please note to Right click on the choice and then choose “Save Link As.”
Clear Configuration	Logged in as Admin, this will restore factory default and remove all configuration information. Logged in as Guest, this will reset all configuration information except for VoIP accounts (SIP1-6 and IAX2) and version number.

d) UPDATE

This page allows uploading configuration files to the equipment.

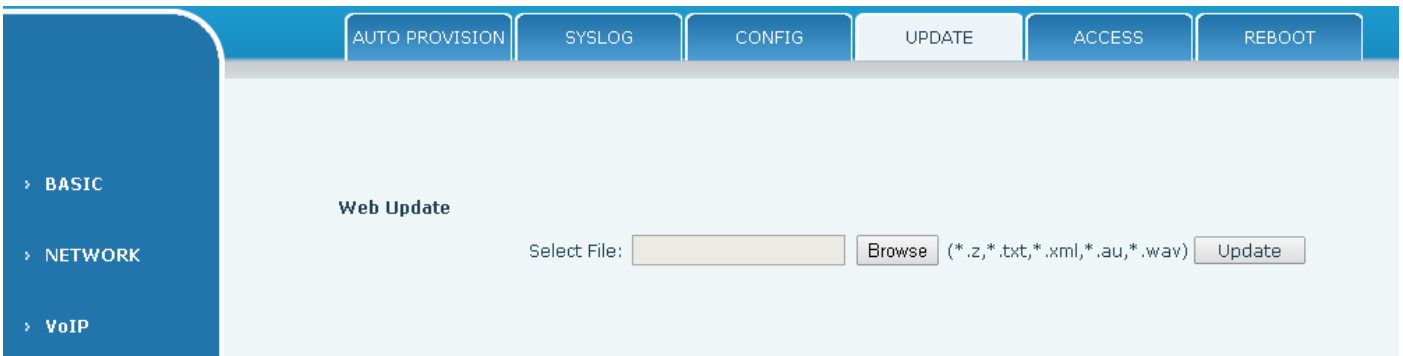

Field Name	Explanation
------------	-------------

<b>Web Update</b>	Browse to the config file, and press Update to load it to the equipment. Various types of files can be loaded here including firmware, ring tones, local phonebook and config files in either text or xml format.
-------------------	---

**e) ACCESS**

Through this page, user can add or remove users depends on their needs and can modify existing user permission.

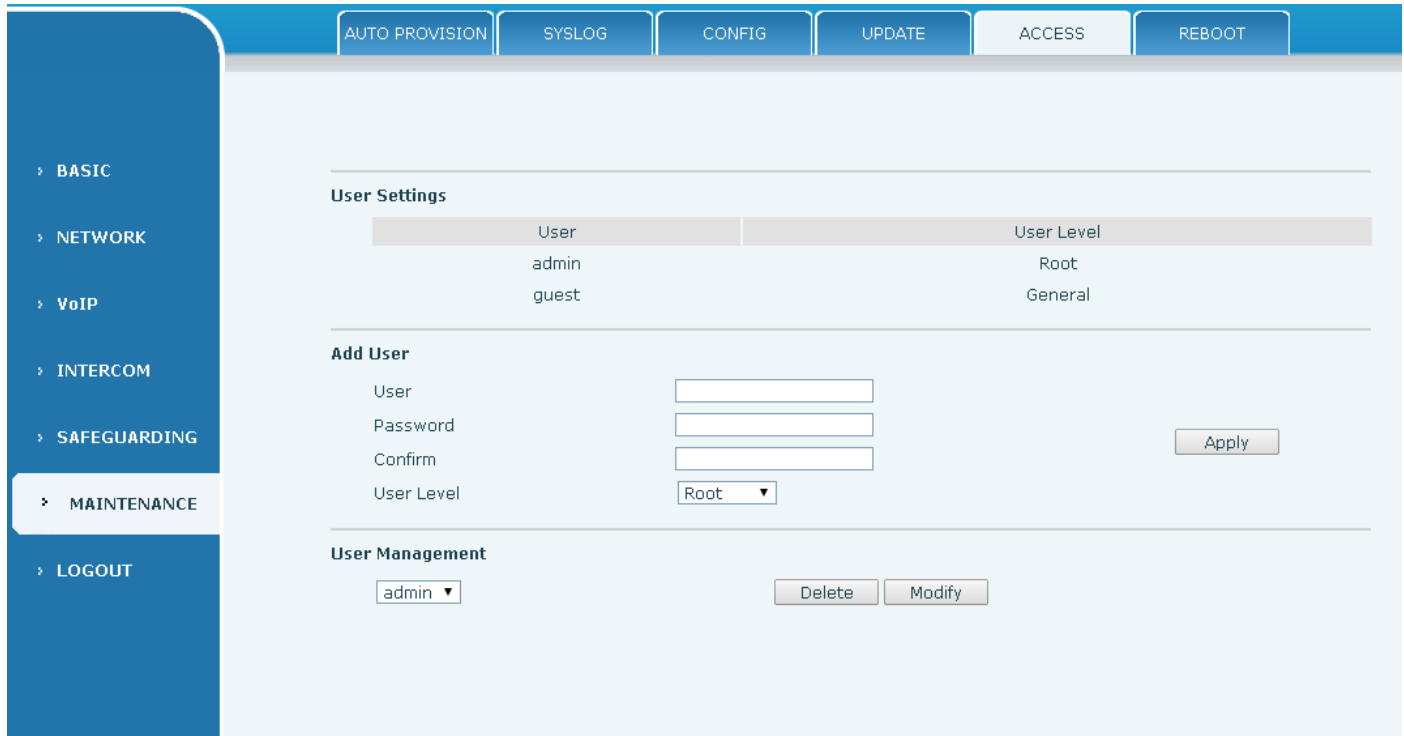

Field Name	Explanation
<b>User Settings</b>	
User	shows the current user name
User level	Show the user level; admin user can modify the configuration. General user can only read the configuration.
<b>Add User</b>	
User	Set User Account name
Password	Set the password
Confirm	Confirm the password
User level	There are two levels. Root user can modify the configuration. General user can only read the configuration.
<b>User Management</b>	
Select the account and click Modify to modify the selected account. Click Delete to delete the selected account. A General user can only add another General user.	

**f) REBOOT**

Some configuration modifications require a reboot to become effective. Clicking the Reboot button will

lead to reboot immediately.

Note: Be sure to save the configuration before rebooting.

## (7) LOGOUT

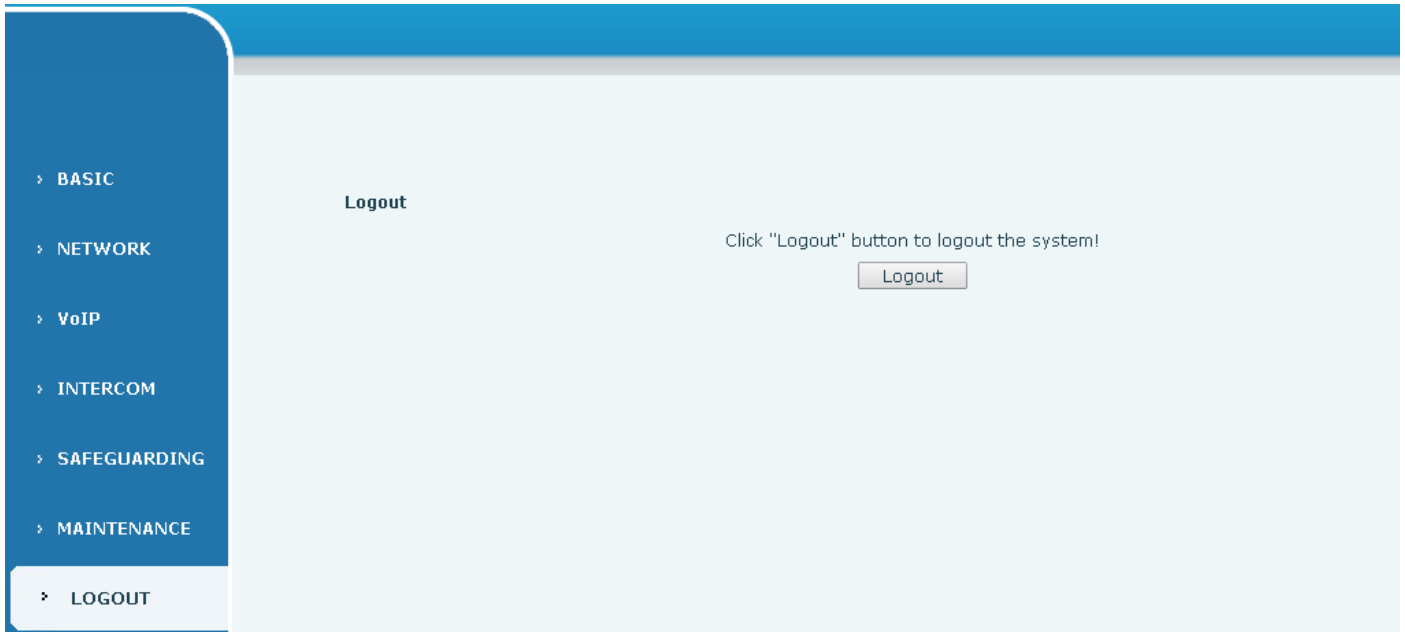

Click <Logout> from the web to exit. Users need to enter their user name and password again when visit next time.

## E. Appendix

### 1. Technical parameters

<b>Communication protocol</b>		SIP 2.0(RFC-3261)
<b>Main chipset</b>		Broadcom
<b>Speech flow</b>	<b>Protocols</b>	RTP/SRTP
	<b>Decoding</b>	G.729、 G.723、 G.711、 G.722、 G.726
	<b>Audio amplifier</b>	2.5W
	<b>Volume control</b>	Adjustable
	<b>Full duplex speakerphone</b>	Support (AEC)
<b>Port</b>	<b>DSS key</b>	One or Two (PH2.0 port)
	<b>Indicating lamp</b>	Three (PH2.0 port)
	<b>MIC</b>	One (XH2.54 port)
	<b>Speaker</b>	One (XH2.54 port)
	<b>An external active speaker</b>	One (3.5mm port)
	<b>recording output</b>	One (3.5mm port)
	<b>Short circuit input</b>	Two (3.5mm port)
	<b>Short circuit output</b>	Two (3.5mm port)
	<b>WAN port</b>	10/100BASE-TX s Auto-MDIX, RJ-45
	<b>LAN port</b>	10/100BASE-TX s Auto-MDIX, RJ-45
<b>power supply mode</b>		9V~16V/1A DC or POE
<b>Cables</b>		CAT5 or better
<b>working temperature</b>		-40 ℃ to 70 ℃
<b>working humidity</b>		10% - 95%
<b>storage temperature</b>		-40 ℃ to 70 ℃
<b>overall dimension</b>		195x120x39mm
<b>Package dimensions</b>		260x165x62mm
<b>Package weight</b>		0.85KG

## 2. Basic functions

- 2 SIP line
- Full-duplex speakerphone
- Intelligent DSS Keys(Speed dial)
- Wall-mount installation
- 2 embedded short circuit input interfaces
- 2 embedded short circuit output interfaces. Support 4 controlled events: remote DTMF; remote server's commands; interaction with short circuit input; talking status
- Output interface for active speaker
- Audio record output interface
- External Power Supply
- Multicast
- All in ONE: Radio and intercom, intelligent security function
- Industrial standard certifications: IP65, IK10, CE/FCC

## 3. Schematic diagram





## 4. The radio terminal configuration notice

✧ How to avoid an incoherency sound when the broadcast playing?

When the terminal use as broadcast, the speaker is loud, if not set mute for microphone, the AEC (echo cancellation) of equipment will be activated, which leads the sound incoherence. In order to avoid such circumstance, when the equipment turn to use as radio should be set as intercom mode, and activate the intercom mute, so as to ensure the broadcast quality.

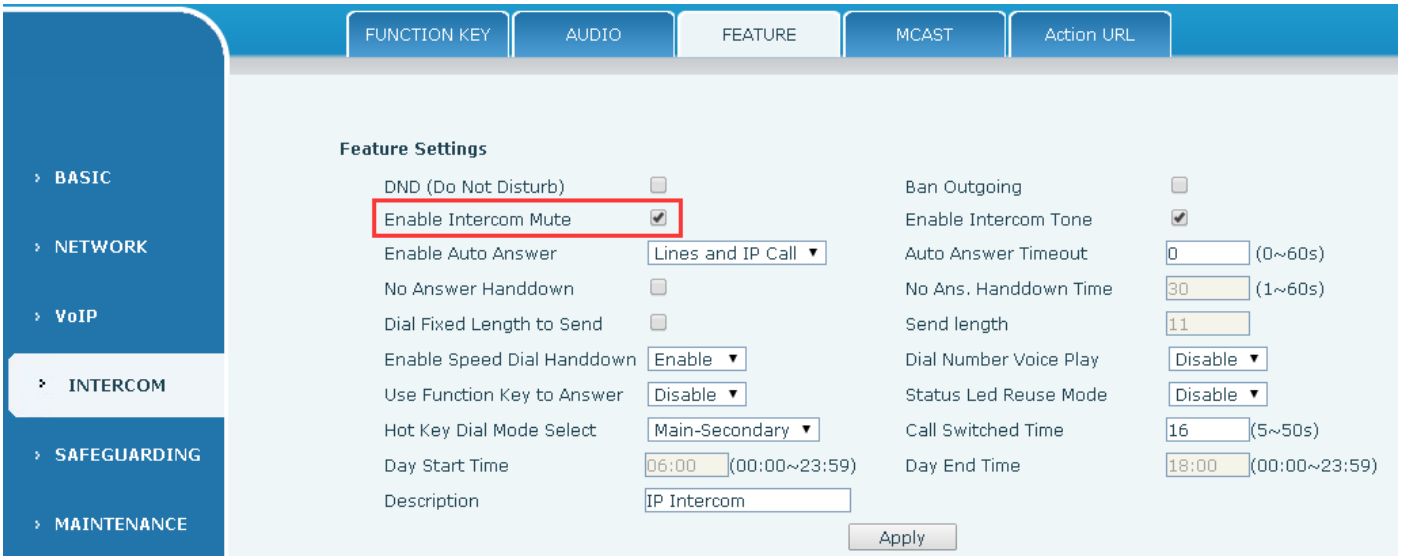

✧ How to improve broadcasting tone quality?

In order to obtain better broadcast quality, recommend the use of the HD (G.722) mode for broadcast.

Voice bandwidth will be by the narrow width (G.722) of 4 KHZ, is extended to broadband (G.722)7 KHZ, when combined with the active speaker, the effect will be better.

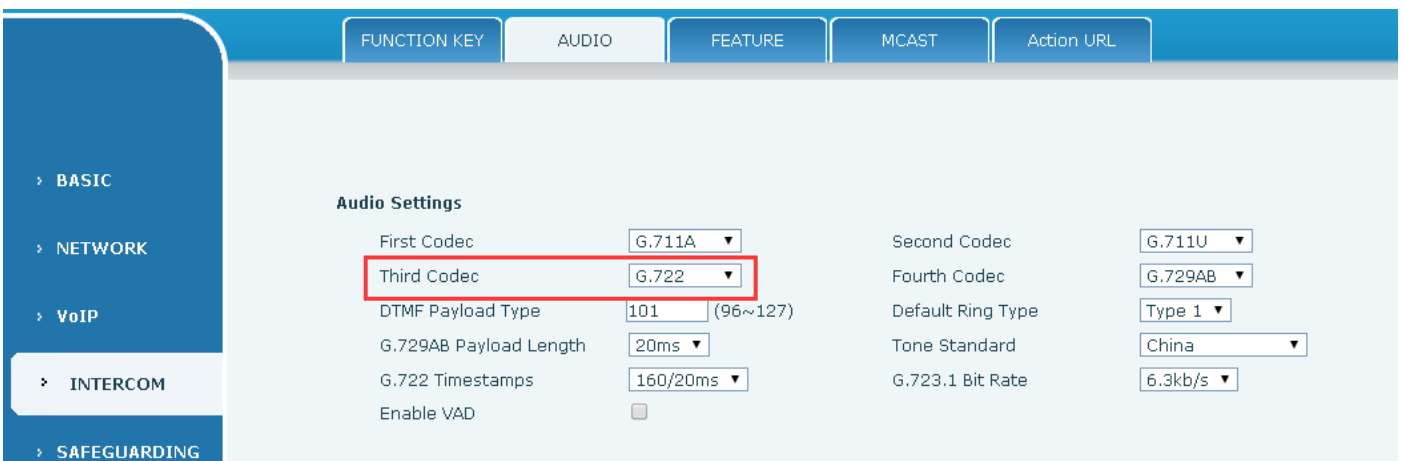

## 5. The other function settings

The screenshot shows the 'Feature Settings' page for the SIP Intercom System. The left sidebar has 'INTERCOM' selected. The main content area has the 'FEATURE' tab active. The settings are as follows:

Setting Name	Value	Range/Unit
DND (Do Not Disturb)	<input type="checkbox"/>	
Enable Intercom Mute	<input checked="" type="checkbox"/>	
Enable Auto Answer	Lines and IP Call	
No Answer Handdown	<input type="checkbox"/>	
Dial Fixed Length to Send	<input type="checkbox"/>	
Enable Speed Dial Handdown	Enable	
Use Function Key to Answer	Disable	
Hot Key Dial Mode Select	Main-Secondary	
Day Start Time	06:00	(00:00~23:59)
Description	IP Intercom	
Ban Outgoing	<input type="checkbox"/>	
Enable Intercom Tone	<input checked="" type="checkbox"/>	
Auto Answer Timeout	0	(0~60s)
No Ans. Handdown Time	30	(1~60s)
Send length	11	
Dial Number Voice Play	Disable	
Status Led Reuse Mode	Disable	
Call Switched Time	16	(5~50s)
Day End Time	18:00	(00:00~23:59)

An 'Apply' button is located at the bottom right of the settings area.

### 1) Status Led reuse mode

Enable the function, the registered status indicator will reuse the call instructions function, which means the LED will flash in the call state.

### 2) Dialing tone prompt

Enable the function; operating digital keyboard will have corresponding key tone of voice.

### 3) Call switching time

This function is used to define the speed dial key to call, call switching from number 1 to number 2 time interval.