

Micro Intelligent Public Address System

MAG2120II

MAG2140II



User's Manual

Thank you for using DSPPA public address system. To ensure optimal operation of this equipment, please read these operational instructions carefully before using.

Guangzhou DSPPA Audio Co.Ltd

<http://www.DSPPA.com>

<http://www.dspstech.com>

Information on Operation Instructions

This Operation Instructions involves MAG2120II and MAG2140II micro intelligent systems for public address system, including function introduction and appearance introduction of products, connection illustrations, settings, operation instructions, precautions, after-sale services, product performance and specifications. Please read this Operation Instructions carefully before connection and operation.

All contents in this Operation Instructions are based on operation of MAG2140II, which are only for illustration. Furthermore, operation methods for MAG2120II are similar to that of MAG2140II. For future use, please make a good disposition of this manual

Content

1. System Overview	4
2、 Performance characteristics	4
3、 Appearance and Functions	5
4、 Connection Description	8
5、 Operation Instructions.....	12
6、 Other Functions.....	31
Packing list.....	34
Specifications.....	36
1 Safety Precautions.....	37
2. Precautions for After-sale Services.....	38
ATTACHMENT	39
Remote Control (Optional)	40

1. System Overview

- Micro intelligent public address system integrates such functions as playing, intelligent timing control, audio matrix, partition control, intelligent firefighting linkage, remote computer control as well as telephone and remote paging.
- Owing to its integral public address functions and individualized intelligent control functions, this address system can better satisfy demands of users of medium and small address systems, such as amplification at such public places as primary and high schools, medium and small plants, parks and square.
- This address system falls into two types as per the number of control zone, namely MAG2120II and MAG2140II. MAG2120II and MAG2140II can control 20 and 40 zones respectively to provide more options for users.

2、 Performance characteristics

1. A public address controller integrating has such functions as playing, intelligent timing control, audio matrix and partition control.
2. It has 5 timing programs. Each timing program is provided with 500 timing points for 7-day circulation. Each timing point is available for control of audio source selection, bell, built-in MP3, AM/FM, 2-way power source, 4 types of external peripheral audio sources (CD, tuner, socket and MP3 program player). The 5 timing programs are easy for switch-over.
3. 8-route common audio source input, built-in MP3, AM/FM, 1-route local aviation microphone input (1st prior function), 1-route alarm signal input (2nd prior function), 1-route remote paging microphone signal input (3rd prior function) and 40-route output large audio matrix.
4. 40-route emergency firefighting input (short-circuit signal), 1-route firefighting linkage output (short-circuit signal used for expansion, which is available for connection with MP99/8815E, MP99/8823S and so on) (each route of emergency input is available for triggering of any programmable and random zone)
5. It is available for connection with external computers through LAN interface for control of the host computer via software (realize auto play as per fixed time, location and program through remote setting). (Such function is to be realized by remote control software as purchased separately)
6. It is available for expansion of remote paging microphone through 9 pin ports.
7. All timing programs are available for instantaneous and easy manual intervention.
8. It is available for real-time monitoring of each zone and volume control (mechanical volume control).
9. It is equipped with ARM9 platform and 5.6-inch color screen + touch pad.
10. It is provided with USB interface used to copy songs in the USB directly to the host computer for play.
11. It can realize 100m wireless remote control with 12 programmable buttons. It can realize customized on/off of zone and selection of audio source and songs with one button.
12. It is provided with 3 types of bell signal output functions (mechanical volume control).
13. It is provided with alarm signal output function (mechanical volume control).
14. It is provided with telephone zone paging functions (mechanical volume control, password alteration, comprehensive paging, optional paging and programmed paging).
15. It is available for timing control of playing status of external audio source.
16. It can realize calibration of touch points on the touch screen.
17. It can be remote control through the road input signal digital volume control function.
18. It can be remote control through 40 way output digital volume control function.

3、 Appearance and Functions

3.1 Front Panel

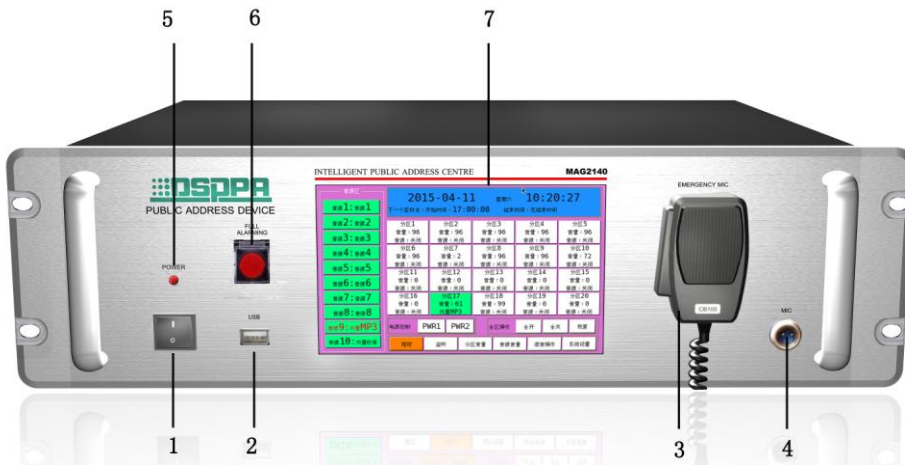

1. Power Switch

Press I and O to switch on and off the power source respectively.

1. USB Interface

It is connected with such memorize as USB stored with MP3 programs and mobile HD for copying of programs to MP3 player, which is available for plug-in of the mouse with USB plug.

3. Microphone Buckle

Be sure to insert the buckle on the back of microphone into this hole when the microphone is not in use.

4. Microphone Interface

Signal of the microphone as connected to this interface has the ultimate priority, which can cover all output signals. The plug connection mode is as follows. Please refer to the instruction manual for the use of the microphone.



5. Power Indicator Light

Indicator light will flash and distinguish respectively when the power is switched on and off.

6. Total Alarm Button

It is applicable to send alarm signals to all zones by the system total alarm button. Button indicator light will flash when the alarm signal is being sent. Button indicator light will extinguish, and the button will spring up once the button is pressed to switch off the alarm.

7. Display Screen / Touch pad

Display screen is for dynamic display of system information and operation of touch screen.

3.2 Back Panel

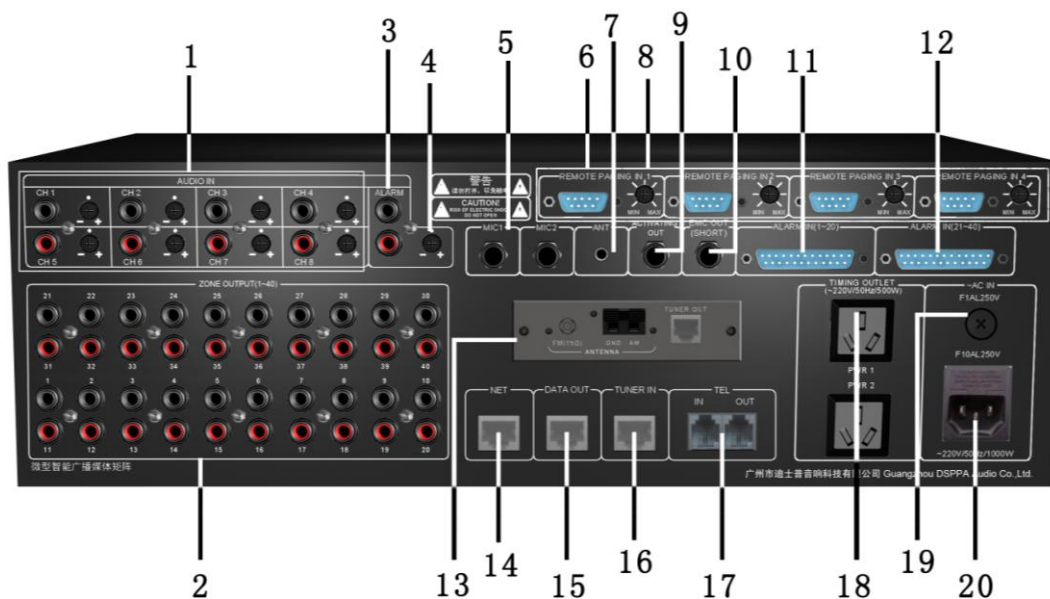

1. 8-route Audio Source Input Interface and Volume Control Knob

8 independent audio source input channels are available for connection with 8 external audio sources. Each channel is provided with one independent volume control knob.

2. 40 Audio Matrix Output Interfaces

Each audio output interface is corresponding to a zone for connection with power amplification audio input interface.

3. External Alarm Signal Input Interface

It can be connected with MP99/8815E (alarm generator) to input alarm signal into the machine and open the corresponding partition alarm automatically. The signal interface has a secondary priority function, secondary priority function only to aviation microphone on the front panel.

4. Alarm Volume Regulation Knob

It is used to control volume of alarm signal as input by MP99/8815E.

5. 2-way MIC microphone interface

2 microphone interface parallel to CH1, CH2 line input.

6. Remote Pager Connection Interface

9-pin D-type data port can be directly connected to remote paging device or paging hub for expansion of numerous remote pagers.

7. Wireless Remote Controlled Receiving Antenna Interface

Connect wireless remote control antenna to this interface. For details, please refer to Description of Wireless Remote Control Functions.

8. Remote Pager Volume Control Knob

It is available for mechanical control of volume of remote pager.

9. Alarm link output interface

10. The power output linkage interface

11. Zone 1-20 Alarm Signal Input Interface

Input signals from firefighting center.

12. Zone 21-40 Alarm Signal Input Interface

Input signals from firefighting center.

13. Built-in Radio Head Module

For radio head module, please refer to Connection of Radio Head Module.

14. Network Interface

It is connected with LAN for remote control of the system.

15. Data Interface

It is for timing control of external audio sources, which is connected with data exchange interface with external audio source.

16. Radio Signal Input Interface

TUNER OUT interface connect with radio head module aims to input radio signals to the machine for play of radio audio sources.

17. Telephone Interface

IN interface aims to connect telecommunication signals to this machine; whereas OUT interface is expected to link up with other telephone sets.

18. Timing power supply linkage short circuit output interface

It provides AC 220V working power supply to external device to control output status via the timing points.

19. AC Fuse Holder

Please use fuse of the same specification to replace damaged one. There might be line faults to the machine in case of continuous blowout of fuse. Be sure to check the line, and use fuse of the same specification to replace the damaged one once the fault is recovered.

20. AC220V Power Input Faucet

This interface is used for switch-in of working power supply to the machine. Be sure insert the plug before connection with power grid in case of connection.

4、 Connection Description

4.1 Input Connection Description

(Audio sources as indicated in the following figure are for illustration only; any user may proceed with connection at his or her discretion.)

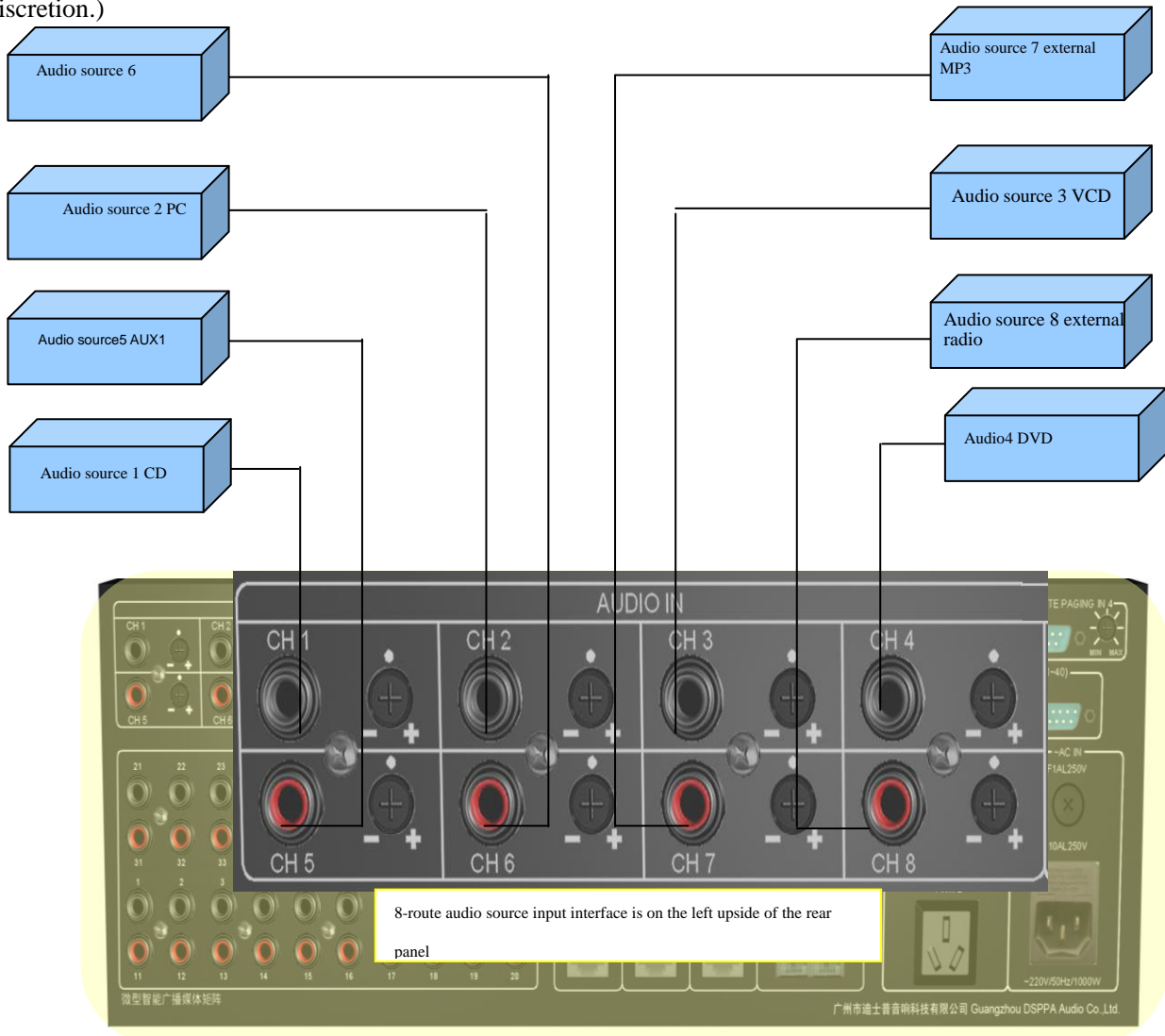

4.2 Description of Output Connection

This machine is expected to distribute 8 external audio sources and 2 built-in ones to 40 audio output ports for output to 40 zones. Each zone is provided with one set of power amplifier to receive audio signals from this machine. Refer to the following figure

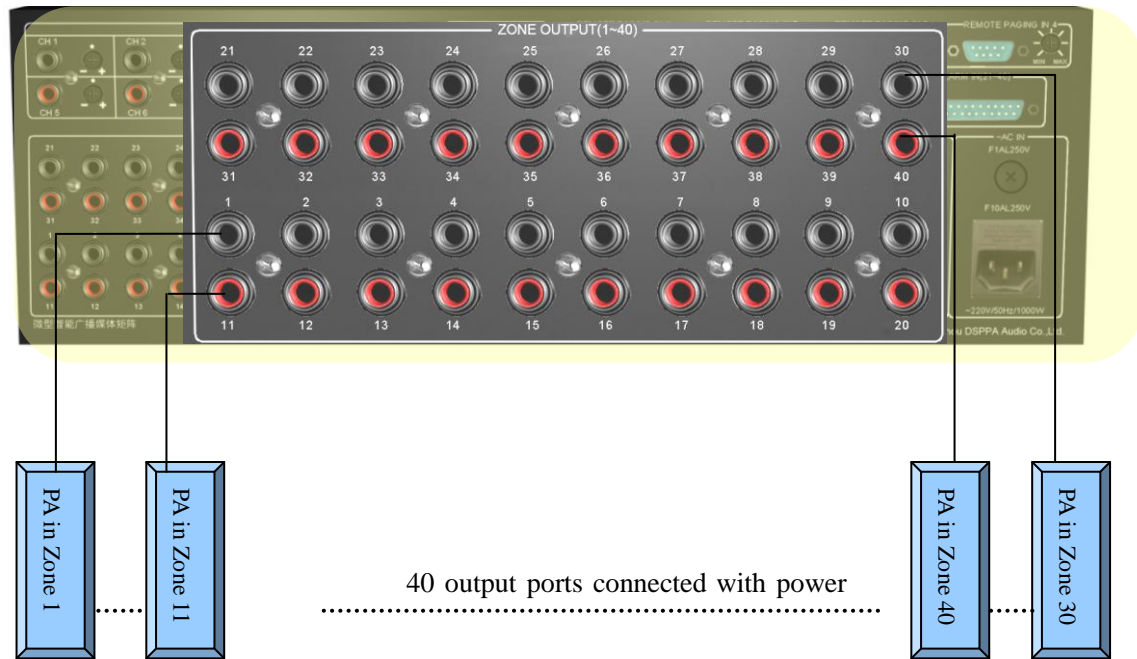

4.3 Other Connections

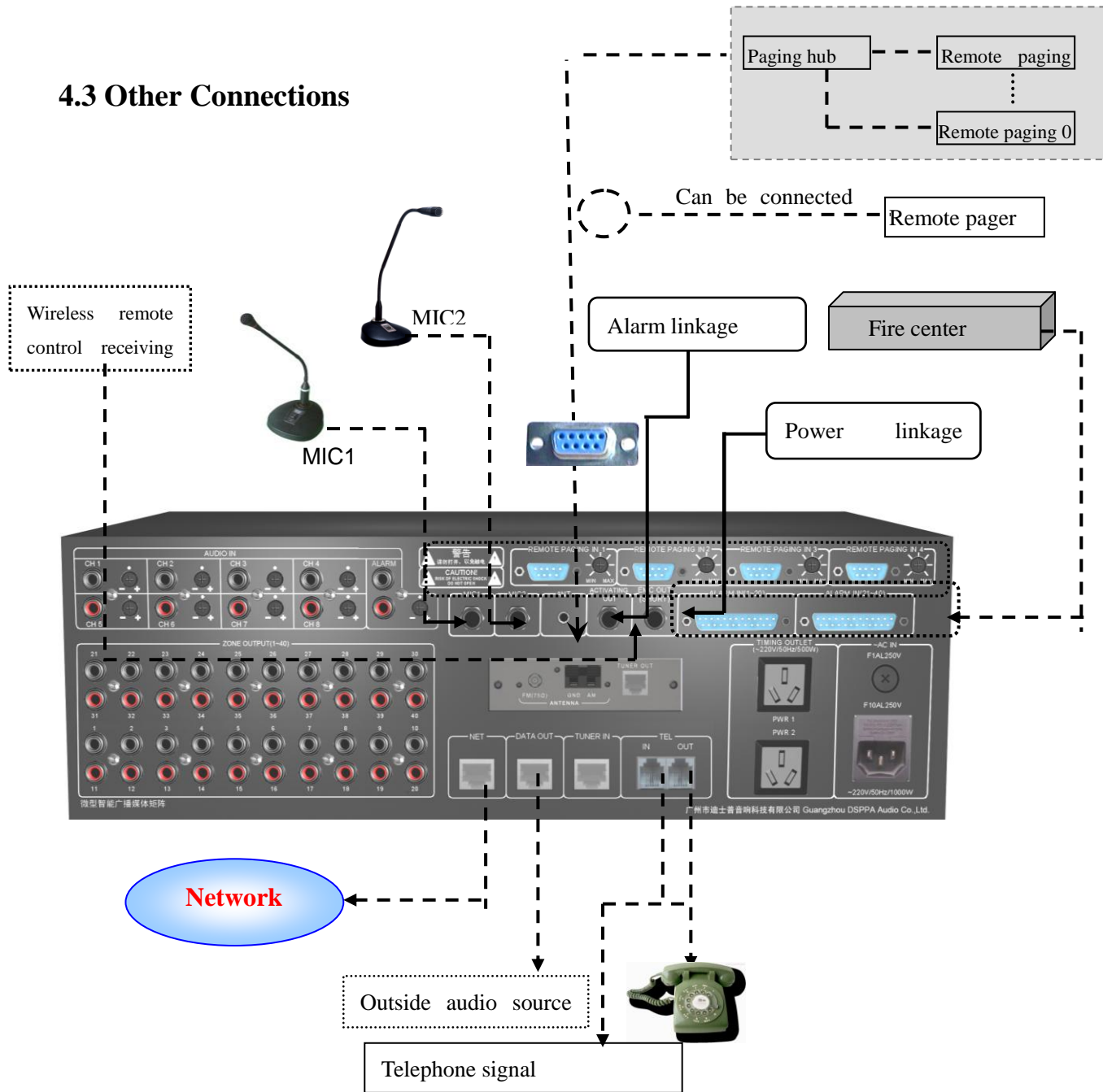

Description:

Make sure that placement of wireless receiving antenna is close to the receiving orientation of wireless remote controller to obtain more satisfactory receiving effect and longer receiving distance.

D-type port is available for direct connection with remote pager or paging hub for expansion of numerous remote pagers.

4.4 Connection of Radio Module

Radio function of this machine is realized by the module, which is available for separation. It is applicable to place radio module at the position of strong receiving signals for connection with extended network line so as to ensure effective improvement of receiving effect. Radio module is connected with this machine with T586 network line. Module as installed on this machine is also available for butt joint on the rear panel through network line.

Prompt: Please fabricate extended connecting line in reference to the following figure if radio module is to be disconnected:

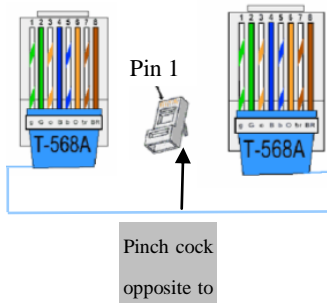

RJ45 interface

Colors for left-right connection

Green-white, green, orange-white and blue

Blue-white, orange, brown-white, brown;

Radio connection mode is as shown in the following figure.

Connection for radio module installation

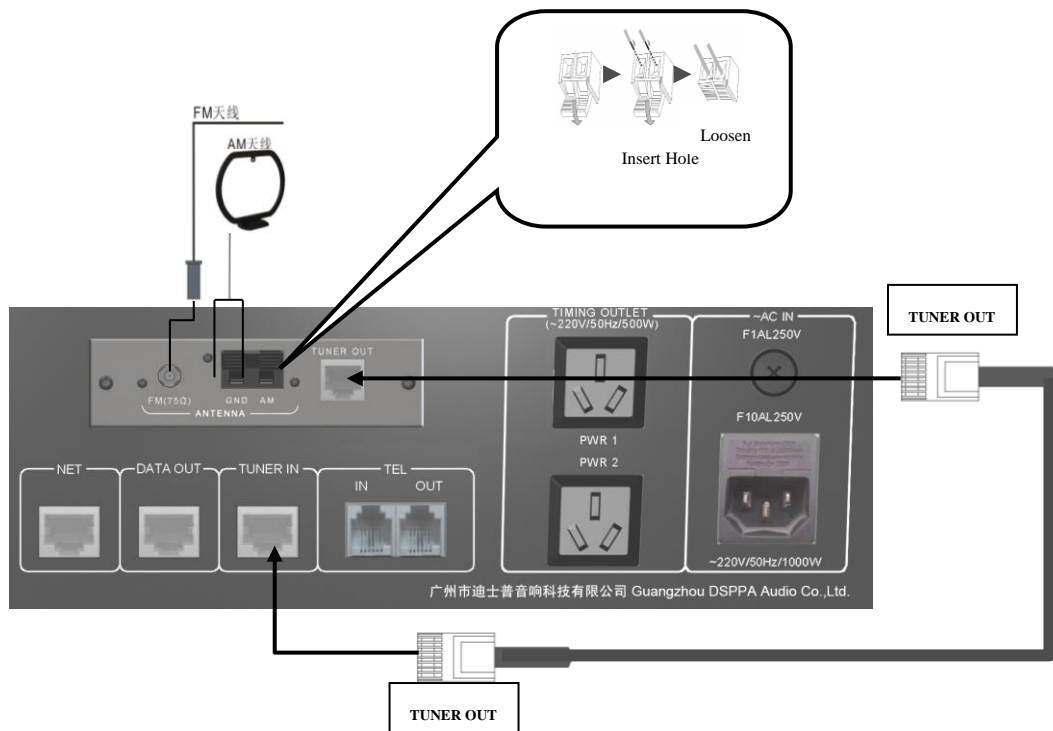

5、 Operation Instructions

5.1 Main Interface

“Welcome! Process Starting, please waiting” will be displayed on the screen once the power is switched on to start the machine. It is applicable to enter the main interface as shown in the following figure after start-up.

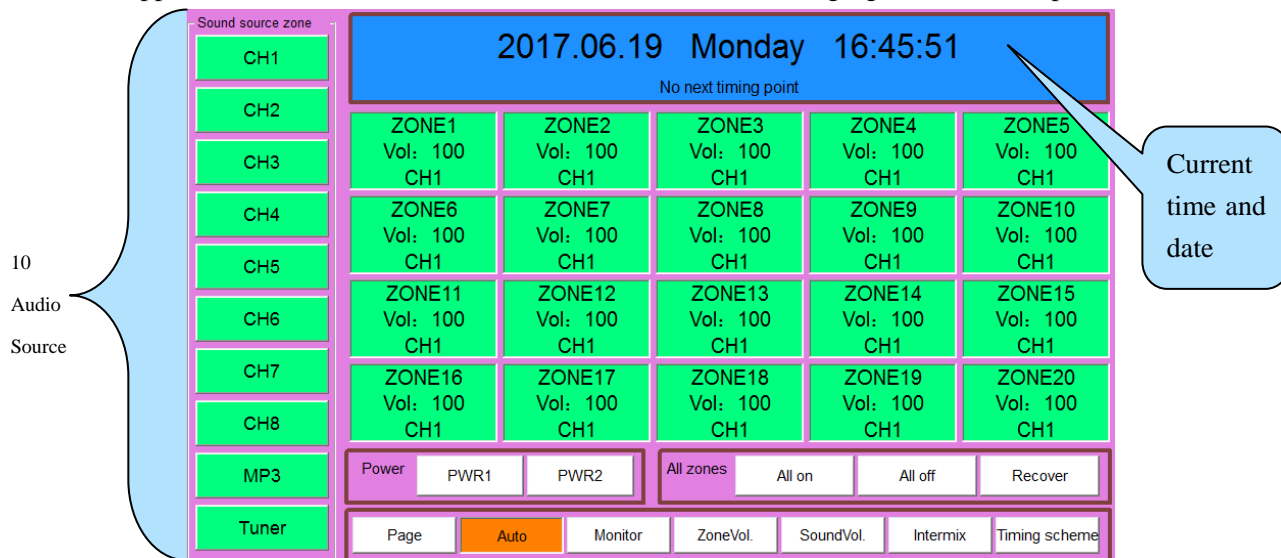

As shown in the aforesaid figure, information as displayed on the main interface include 10 audio sources, current time, status and operation of 40 zones, power output control status and operation, programmed/manual control setting, monitoring setting, timing program selection and system access setting.

1) Distribution of external audio sources

Enter the main interface to play programs in corresponding zones. Firstly, select corresponding audio source for distribution to the zone where it is to be played. Specific operation is stated as follows: Select audio source to be displayed in “audio source zone” (if CH4 audio source is selected, audio source button will be sunken; whereas red color showing selected audio source is to be displayed). After that, click the zone where the audio source is to be played. It will be available for play once zone button is in green color, and audio source is displayed.

Prompt: Be sure to make sure that programs are being played by the external audio source to be distributed to the corresponding zone or switch such audio source to the play status after distribution. Caution: Audio source selection will be invalid if current zone is at paging, warning, and call or aviation microphone paging status.

2) Distribution of Built-in Audio Source

CH9 and CH10 in audio source zone belong to built-in audio sources. Each built-in audio source is provided with a player that can be turned on directly for setting of play status. Click the audio source button (such as CH9 button) to enter the play status operation interface (as shown in the following figure, random setting of MP3 programs to be played is available in the play interface) during operation.

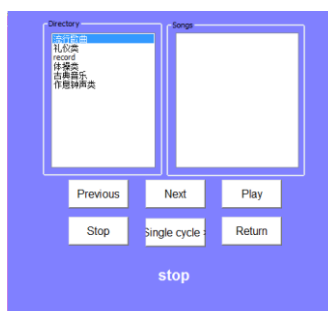

(Figure2 MP3 player)



Play operation, choose the “catalog of songs” on the left side firstly. Songs in the catalog will be displayed in the play-list on the right side. After that, proceed with setting of play mode (such as “loop play”) in the “mode selection” on the left corner of the interface before clicking “play” button to play. Click “back” to return to the main interface after play, and then click corresponding zone directly to distribute MP3 audio source to the zone where such audio source is to be played. Distribution mode for radio audio source is identical to that of MP3 audio source.

It is applicable to enter the radio play interface to select play status once “radio” audio source is selected. As shown in the following figure, radio play operations include band switching, radio station searching and storage as well as mute setting.

Note: Ensure correct connection of radio module on the rear panel of the machine.



(Figure3 Tuner)

- ① Band switching: As shown in the aforesaid figure, “BAND” on the interface is used for band switching. It is applicable to click this button for switching between AM and FM. Frequency band of AM and FM is 522kHz-1620kHz and 87.00MHz-108.00MHz respectively.
- ② Radio station searching: Click “AUTO” to select radio stations before clicking  forward and backward auto searching. Searching will come to a stop once any station is discovered.
- ③ Station memory: Any station as searched is available for numbered memory to facilitate timing control and further use. AM and FM are provided with 40 memory numbers respectively for storage of 40 station channels. Once any station is searched, click “MEMO” to change the button into orange color, and then push the  to select memory number. Once corresponding memory number is selected, click “MEMO” again to change the button into white color to complete station memory.
- ④ Mute: As shown in the aforesaid figure, the button will be in orange color once the “MUTE” is clicked. Meanwhile, speaker icon at the right upper corner will be switched to the status as shown in the figure. This

indicates that radio is switched to mute mode. The button will be in white color again if “MUTE” is clicked to cancel the mute mode.

3) Zone Switch Operation

Zone switch is available for both individual and synchronous control. As shown in the main interface, only zone 1-20 are displayed on the interface. It is necessary to use page rolling button (as shown in the following figure) for display of zone 21-40.

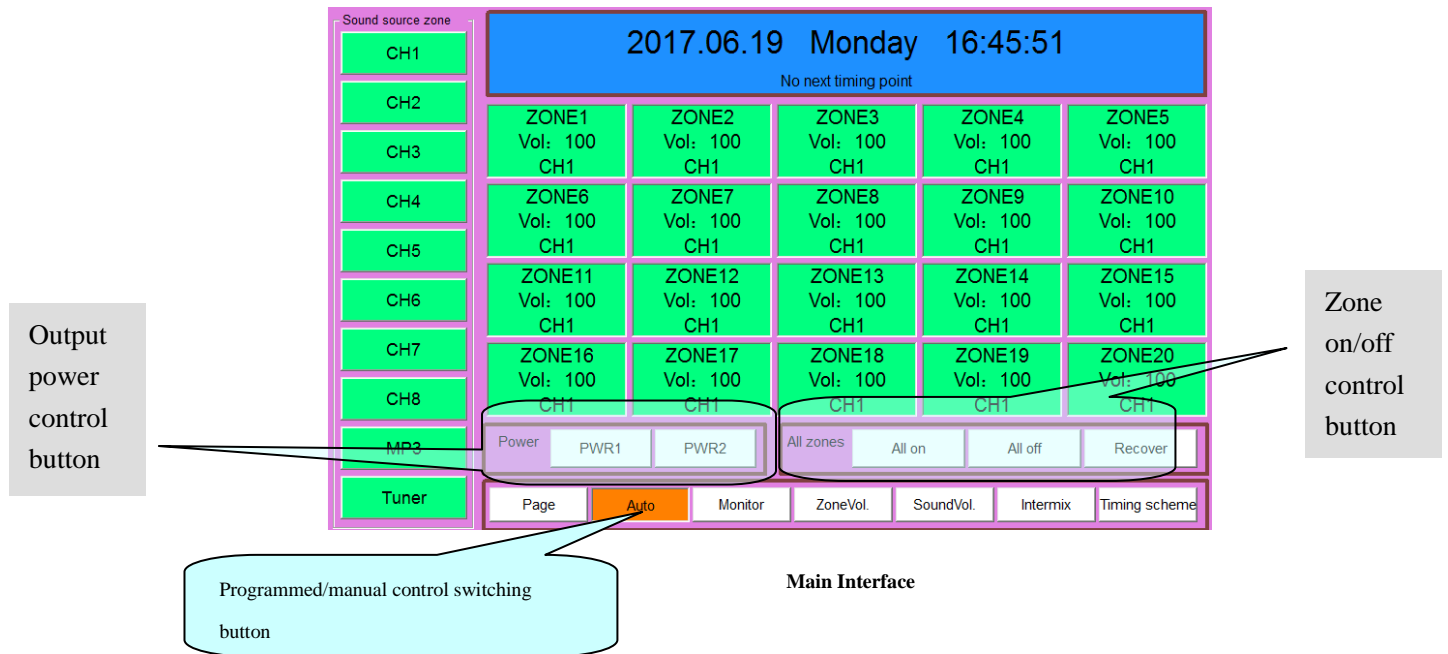

Click zoning button directly for switching operation. The button will be in white and green colors respectively when corresponding zone is closed and opened. Furthermore, audio source for the said zone will also be displayed on the zoning button. It is also applicable to proceed with overall synchronous operation of the zone. Operation button is as shown in the aforesaid figure.

4) Output power source

As shown in the aforesaid figure, PWR1 and PWR 2 are control buttons for output power 1 and 2 respectively. It is applicable to proceed with switching control of output power by clicking such buttons directly. Output power is also available for auto timing control.

5) Programmed / manual switching

As shown in the aforesaid figure, it is applicable to click “programmed/manual control” button directly for switching between programmed and manual modes.

Note: Be sure to set this button at preset “programmed” timing point for execution. All timing points will unavailable for execution if such button is in “manual control” mode.

6) Monitoring Setting

This machine is available for monitoring of each zone. Click “monitoring setting” button to enter the monitoring interface as shown in the following figure in case of operation.

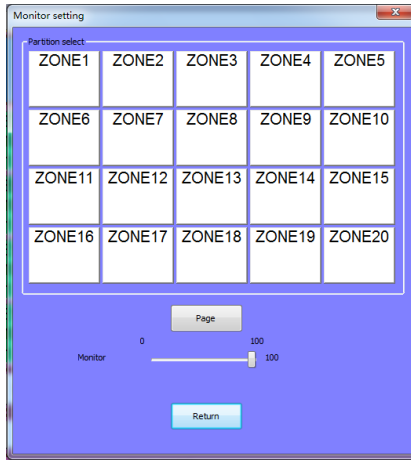
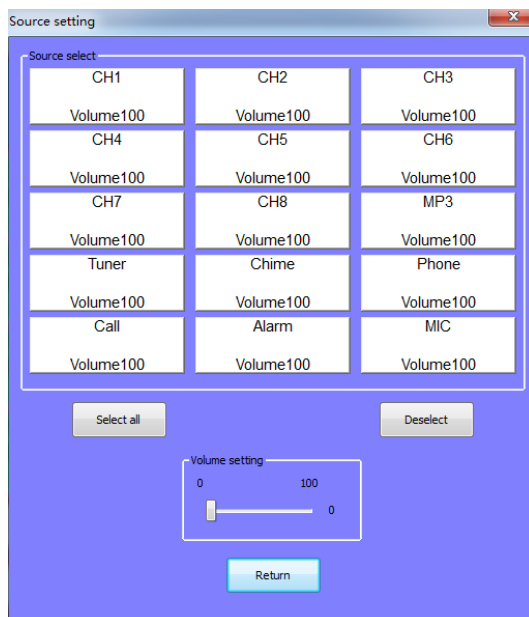

Figure 4 Monitoring Setting

It is applicable to monitor zone status by clicking zone button on the monitoring interface directly. The button will be in green color when the zone is under monitoring; whereas “×” before the speaker icon will be changed into “√”. Use “Page Rolling” button to open the display interface for zone 21-4 to be monitored. After that, press zone button for monitoring.

7) Partition volume control

By using the digital volume adjusting partition volume, digital equalization settings, convenient operation and clear, can choose a single partition volume adjustment, can also choose "select" button, all the partition volume adjustment or cancellation of choice. First click on the main interface on the partition volume adjustment button, enter the "partition volume adjustment" interface, the interface is as follows (Figure 5), click on the partition operation is as follows: 1, (when the partition is selected, the button turns green, to partition the set volume value, slide the bottom left of the left and right mouse button to adjust the volume, the 1 District Partition volume on the automatic synchronization display adjusting the volume value, can also be balanced set the volume. The other partition and so on, set the volume, clicks the "back" button, exit partition volume control settings.



8) Sound volume

Click the source volume button on main interface , enter the audio volume control interface, the interface (Figure 7) shows as follows, regulate the sound volume and partition the volume control setting method of the same, this is no longer in this paper.

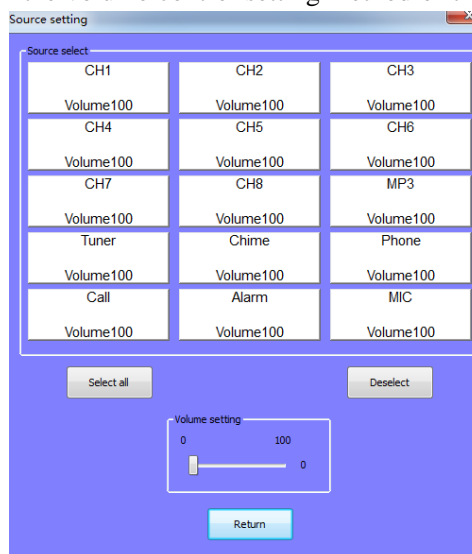

9) Mixing operation

Click on the main interface of the "mix" button, enter the mixing operation interface. The interface is as follows (Figure 8) shows the input audio select 3 audio mixer respectively, operation setting. click on the left side of the small box, when the small box color turns green, click on the right side of the lower triangular symbols, a total of 15 kinds of audio input, in the drop-down box choose a source (for example the selection of source 7), mixing source 2 (selected source 5) and mixed audio choice 3 the same operation, arbitrary selection of an audio output, namely the input source 7 and the input source 5 at the same time, through the built-in MP3 audio output.

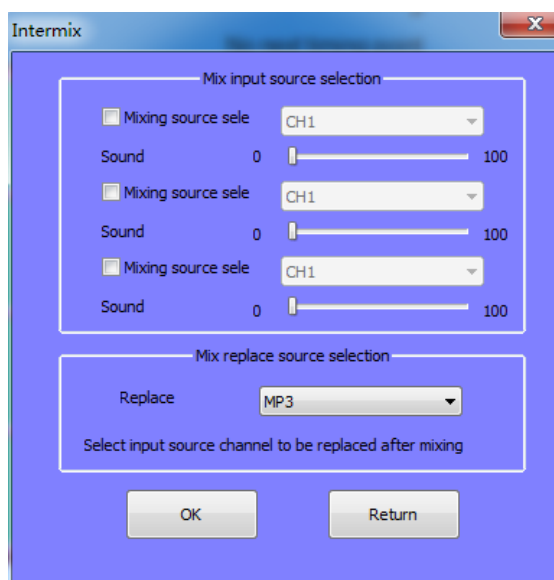

5.2 System Setting

Click “System Setting” on the main interface to enter system setting interface as shown in the following figure: It is applicable to proceed with setting of overall system information on the system setting interface. Be sure to ensure proper setting of all options on the system setting interface before play on the main

interface. This aims to ensure accurate execution and operation of various system functions.

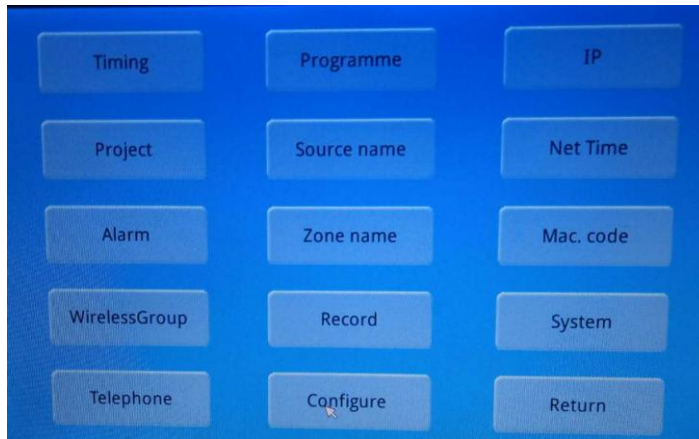

Figure 9 System Setting

1) Timing setting

Click “Timing Setting” button to enter the timing setting interface as shown in the following figure:

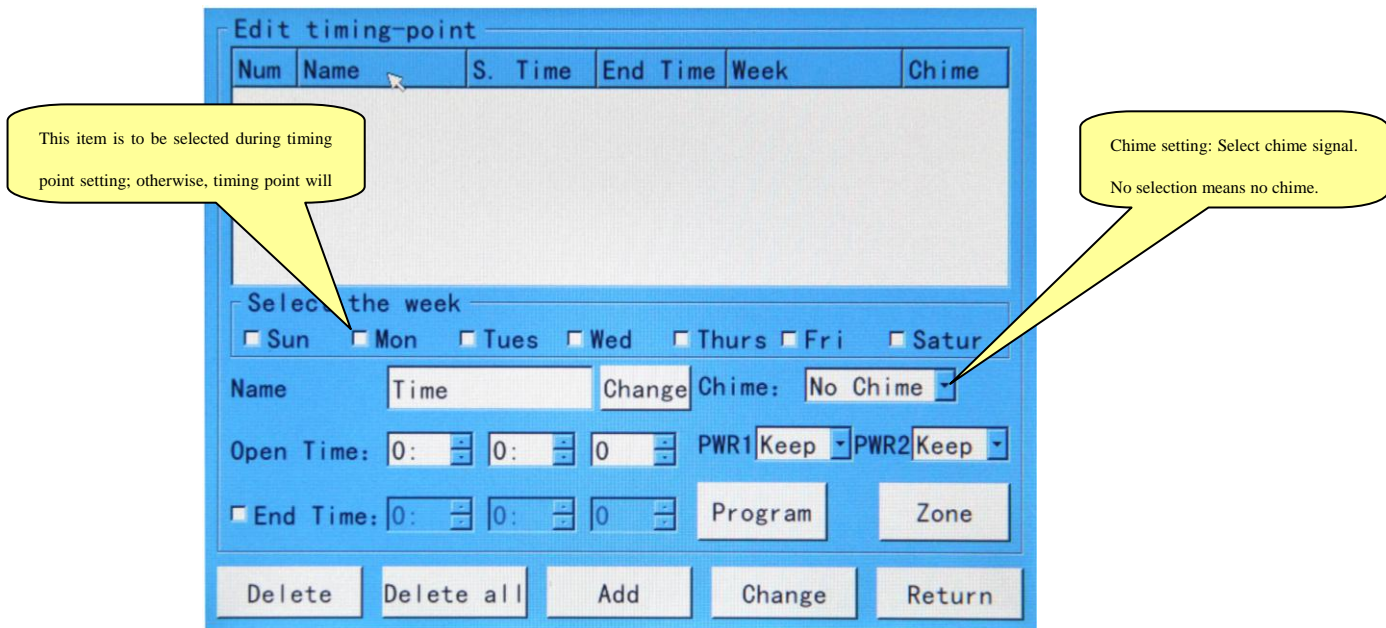

Figure 10 Timine Setting

This interface is for editing various functional information on timing points:

- ① Week selection: This operation aims to select the date of timing points. For instance, it is applicable to select corresponding date in the block of “Monday-Friday” if timing points are to be executed from Monday to Friday (“√” in the block represents selected date).
- ② Designations of timing points: Define designation for edited timing points. For instance, timing point representing wake-up bell can be defined as “Wake-up”. Open the designation editing button board (click the functional button of “Alteration” on the right side of timing point designation block) to enter the editing button board interface (as shown in the following figure). After that, select Chinese or English at the bottom right corner

of the button board. Input timing point, and click the “Confirm” button at the bottom to complete editing, and exit the button board.

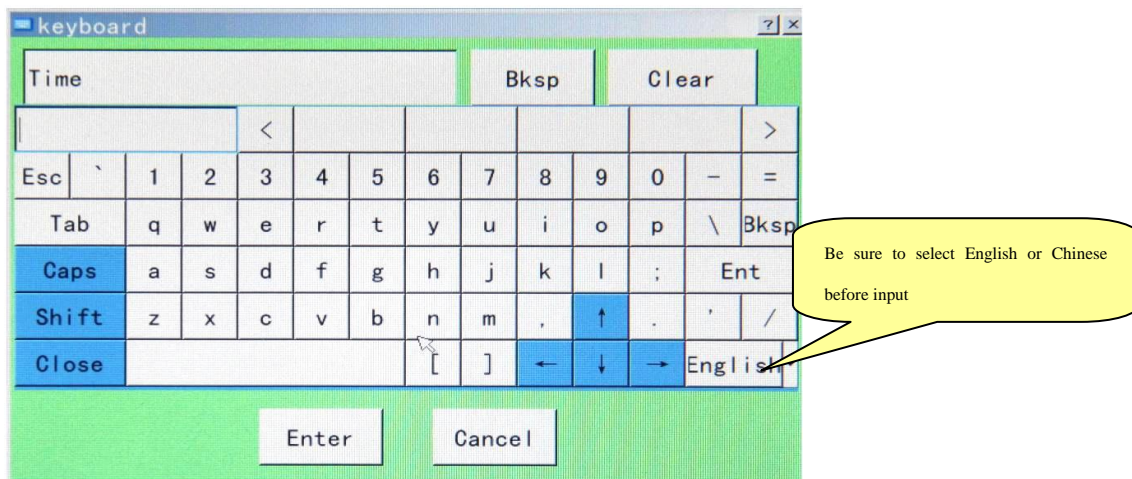
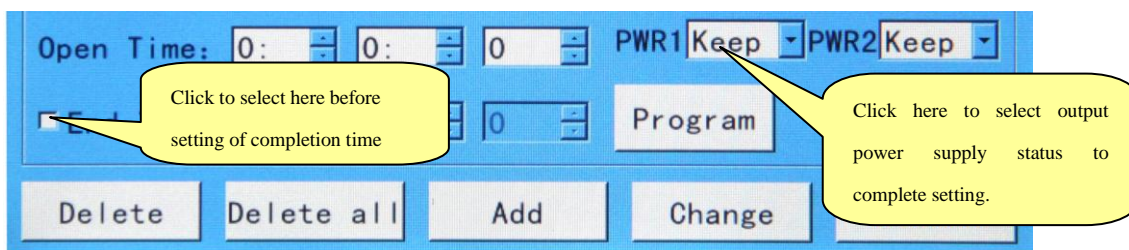

Figure 11 Timing point naming editor keyboard

- ③ Bell selection: There are 3 bell signals available for selection in the system. Click inverted triangular symbol after the “Bell”, and select bell signal on the drop down menu. The 3 bell signals are defined as bell 1, 2 and 3 respectively. Click the selected bell for one time to display its designation.
- ④ Timing time: This setting aims to edit start time of timing points. It is applicable to alter the time by click black triangular symbol beside the time block. Timing time of the system is accurate to second. Timing to the second will not be required if not necessary.

Note: The start time of the same timing point at different dates cannot be set to the same after a day than the previous day need to lag 1 second. For example, Monday has 7:00 for the start time of the timing point, thus can't set the 7:00 for the starting time on Tuesday. The start time must be set to 7:01. On Wednesday at the same time the timing of the start time is needed to set to 7:02, On Thursday and so on.

- ⑤ Output power supply control: “PWR1, PWR2” behind the “Timing Time” is used to control switching status of two-route power supply on the rear control panel. Click corresponding block for one time to select required power supply status on the drop down menu to complete setting.
- ⑥ Completion time: Method for setting of completion time is identical to that for start time. The only difference is that the system has optional requirement for completion time. In other words, completion time may be required or not required as per specific demands, which is to be defined as per timing points.



(Figure 12) Indication of Output Power Supply and Completion Time

- ⑦ Program selection: This operation aims to select operative audio source for timing points. Select “Program

Selection” button to enter the program setting interface as shown in Figure (10), (11) and (12). One built-in timing point is available for timed play control of built-in MP3, built-in radio and 4 external audio source

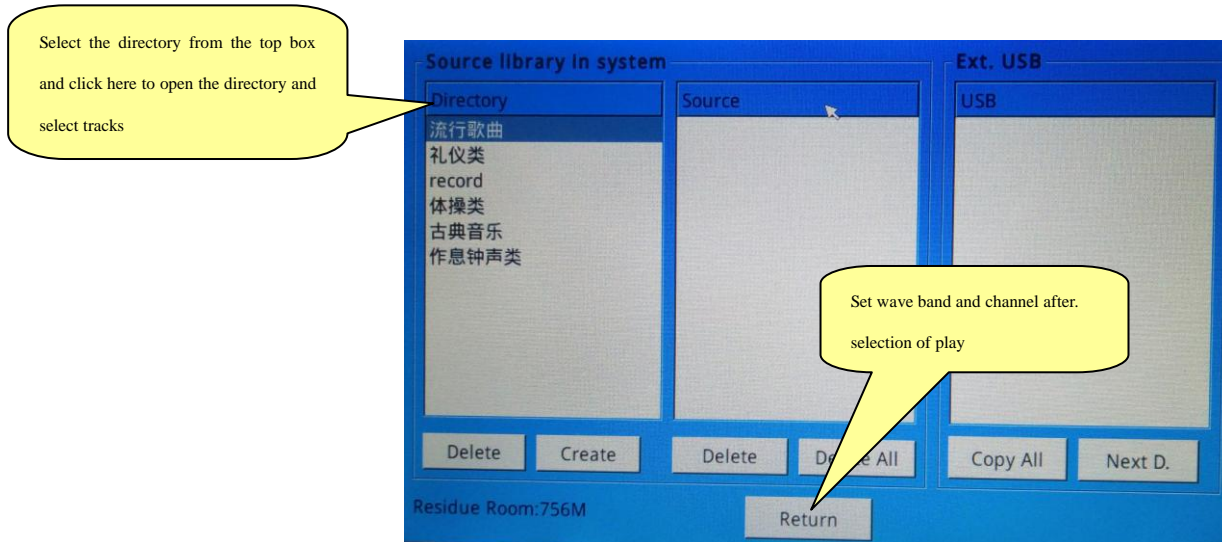

(Figure 13) Setting Audio Sources for Timing Points

As shown in Figure (13), click “Add” button to select catalog when setting built-in MP3 programs (such as selection of “common comity”). After that, click “Next Catalog” to open the catalog, and select songs to be played. Once completed, click the “Add” button, and designations of selected songs will appear in the play list of “Selected Songs”. It is also applicable delete any song from the play list of “Selected Songs”. Specific method is stated as follows: Select the song to be deleted, and click “Del” on the right side.

Select required control status among “Uncontrolled”, “Play” and “Stop” at the bottom right corner of the interface prior to editing when setting built-in radio programs (as shown in Figure 13). Note: Be sure to set wave band and channel after selection of play status. Channel number represents the memory number of station as stored in the radio tuner. Radio function at corresponding timing point will be invalid if the selected memory number is not stored with any station

Setting of external audio sources involves the following operations: Selection of audio equipment types, control modes (play or stop) and programs. Click “Add” to add the audio source into the list of “Controlled Equipment” once any equipment (such as holder) to be controlled by the timing point is selected. It is also applicable to delete any uncontrolled equipment from the list (as shown in Figure 15).

Click “Return” button at the bottom to exit the audio source setting interface once all items are set.

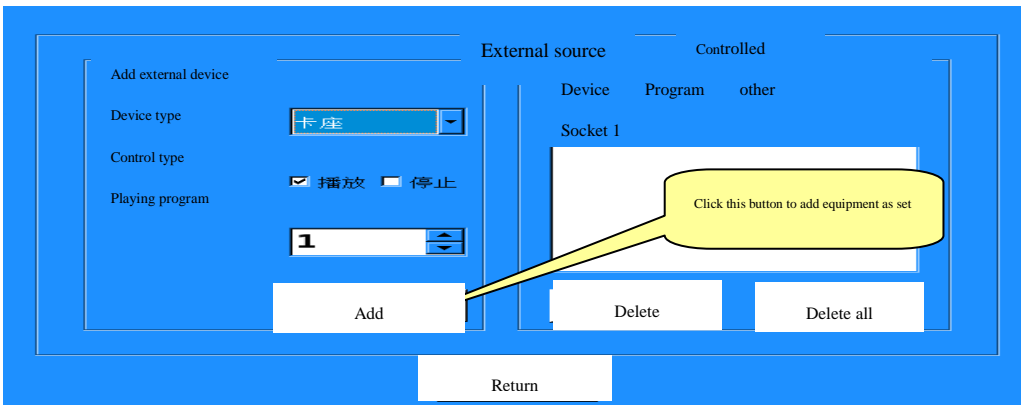

(Figure 15) Audio Sources for Timing Points

⑧

Zone selection: Click “Zone Selection” button on the timing setting interface to enter the zone selection interface as shown in the following figure (Figure 16).

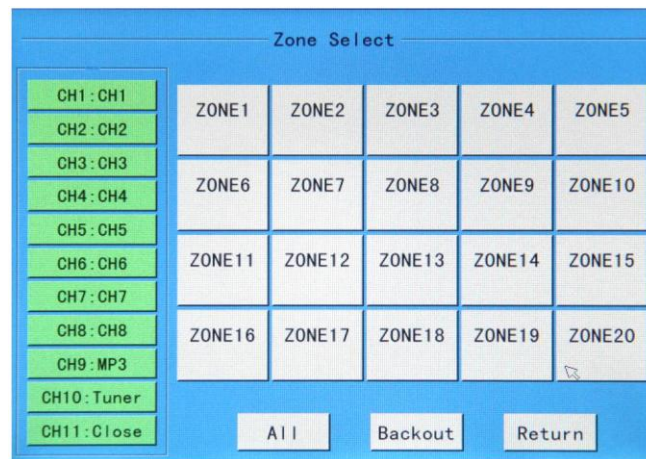

(Figure16) Select partition

Any timing point in this system can control play status of 6 audio sources. The 6 audio sources are available for free selection in the corresponding zone. In other words, all zones at one timing point can play different programs.

Firstly, select audio sources to be distributed to corresponding zone in case of setting. For instance, it is necessary to select “external radio” audio source, and click buttons in zone 1-10 if external radio is to be distributed to zone 1-10. Under such circumstance, corresponding button will be in green color to display “external radio”. If all audio sources subjecting to timing control are to be distributed to corresponding timing control zone, just click “Back” to exit the interface to complete timing setting of corresponding zone .

- ⑨ Once items for timing points are set, click “Add” to add such items into the timing list.
- ⑩ Deletion of timing points: Timing points can be deleted by clicking individual and whole deletion buttons. “Del” aims to delete certain selected timing point in the timing list; whereas “Delete All” is expected to delete all timing points.
- ⑪ Saving of timing points: Click “Add” to save one timing point as edited in the system. After that, click “Back” to

exit the timing point setting interface.

2) Timing scheme

In the "system settings" interface, click the "timing scheme" button to pop up the timing scheme selection interface, interface as shown in the following figure (Figure 17) .Here chose to determine a timing scheme and programming from time to time in editing the timing point will be automatically saved in the set of timing scheme. In time before programming, it is recommended to here choice timing schemes, so according to the need to edit out 5 sets of timing scheme, convenient later call. In this interface, to the current 5 sets of timing scheme for renaming, save scheme as shown in Figure 18, figure 19

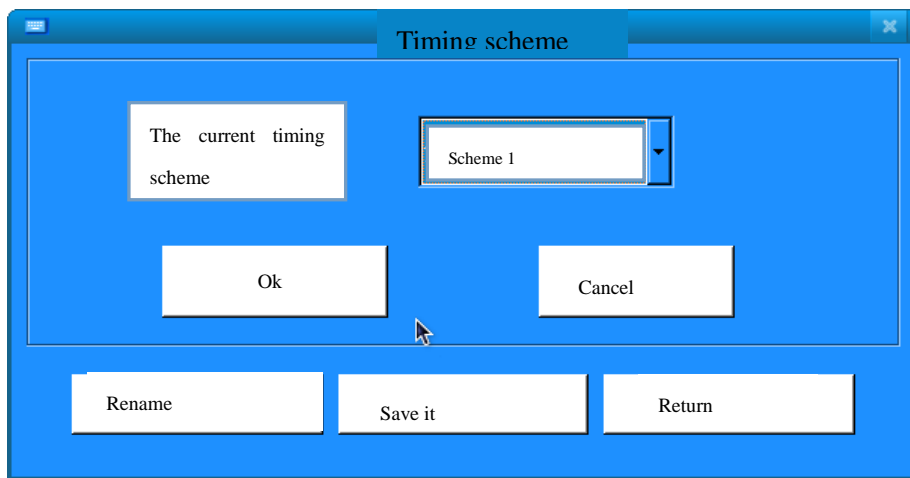

(Figure17) Timing scheme

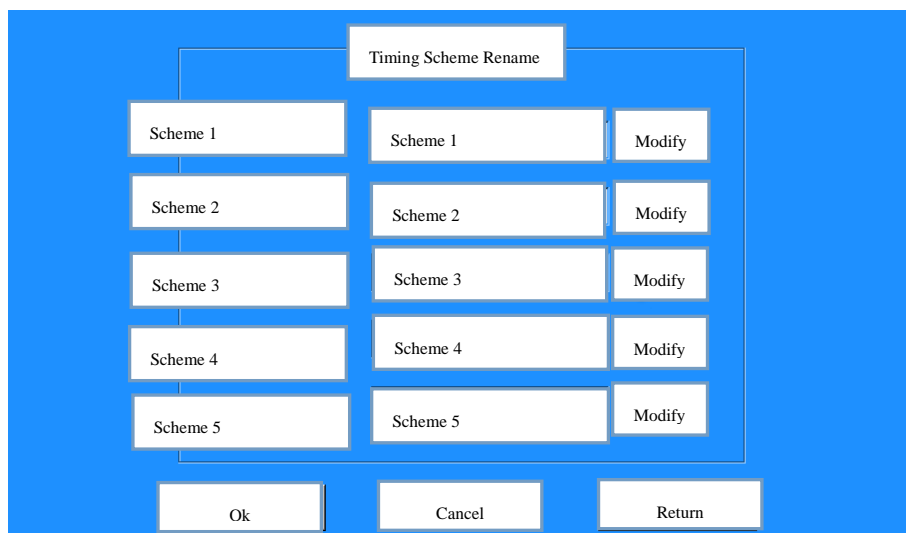

(Figure 18) Selecting Partition

To rename the timing scheme, click "Rename" enter (Figure 18) timing scheme named interface, the public has 5 sets of programs, such as to rename the first set of options, click behind the "modify" button, enter edit interface, keyboard, as shown in (Figure 19), input file name, and click on the bottom of the OK

button, can complete the rename edit and exit the keyboard and other operations.

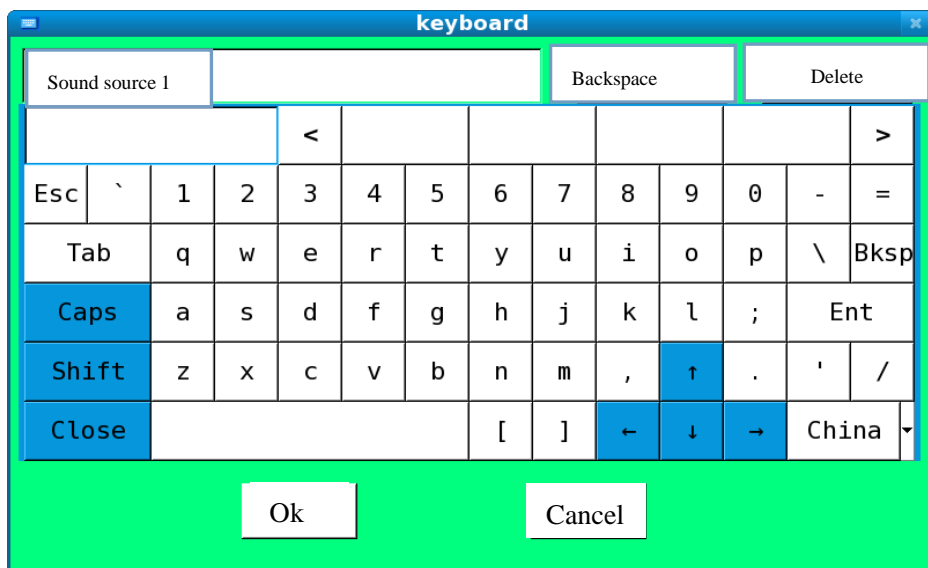

(Figure 19) keyboard editing interface

3) Program Setting

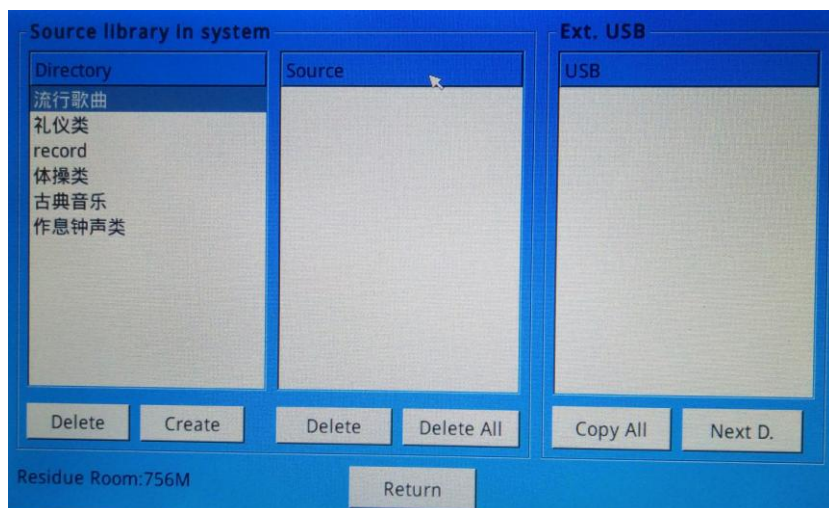

Click “Program Setting” on the “System Setting” interface to enter the setting interface as shown in the following figure (Figure 20):

“Program Setting” for system setting aims to edit music library of built-in MP3, including browse, copy and deletion of songs. As shown in the aforesaid figure, once certain catalog in the catalog block on the right side is selected; all songs in it will be displayed in the central program block. Once programs in such block are selected, it will be applicable to proceed with deletion operation by using deletion button at the bottom of the interface.

Block on the right side of the interface aims to display programs in the USB on the front panel. Once song designations are directly displayed in this block, it will be applicable to select relevant songs. After that,

click “Individual Copy” button below the block to copy selected songs into the machine. In the event that catalog is displayed in the block below “USB Device”, just select certain catalog, and click “Next Catalog” below the block to enter the play list before copy programs.

Tips: when insert the U disk to the device, waiting for 10 seconds until the disk program can display in the directory column. There are some individual U disk can't fine the files. So users can to return to the main interface of the system, re-entering the track settings interface can find U disk file.

If catalog is displayed in the block below “USB Device”, just select this catalog, and click “Copy all” to copy all songs in this catalog into the machine.

Note: As music library of the system is only provided with one catalog, any song under the catalog additionally established is unavailable for play. Therefore, never copy songs to the system music library when copying programs.

4) Alarm Setting

Click “Alarm Setting” button on the “System Setting” interface to enter alarm setting interface as shown in the following figure (Figure 17). It is applicable to set alarm zone linkage, alarm audio source and alarm triggering level on this interface.

Be sure to properly set “Alarm Audio Source Setting” and “Alarm Level” below this interface in case of setting. After that, select one certain alarm channel (such as CHN1) in the “Alarm Channel” block on the left side. Once completed, select alarm zone to be triggered by CH1 in the “Triggering Zone Setting” on the right side. It is applicable to select single or all zones or cancel the selection.

If “Alarm Time” is not selected, the system will initiate internal alarm whistle as alarm signal when external alarm audio source is actuated for alarm. If such option is selected, just use externally input alarm signal in priority instead of using internal alarm whistle in case of alarm. Make sure that external alarm equipment has been properly connected under such circumstance.

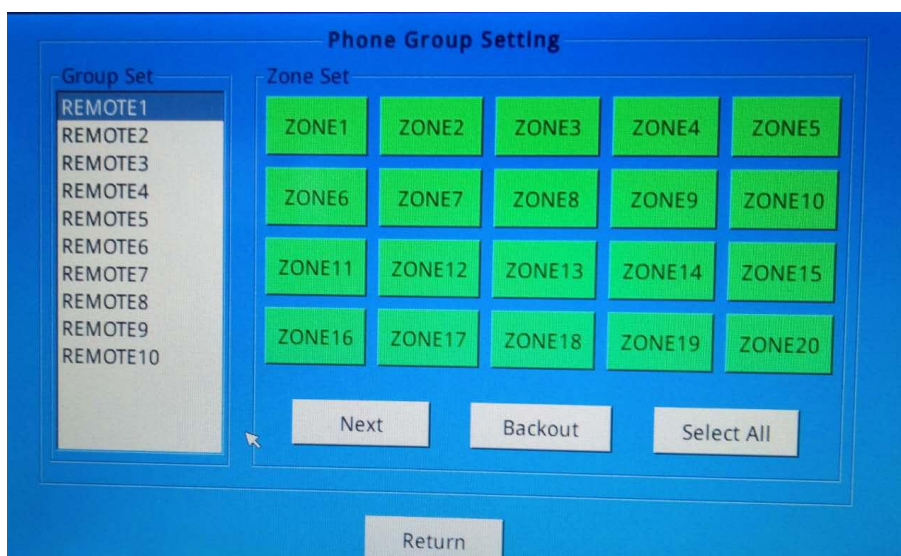

5) Wireless Process Setting

Click “Wireless Process Setting” button on “System Setting” interface to enter wireless process setting interface as shown in the following figure (Figure 16). This system can be controlled with wireless controller in the control mode identical to that for timing points. Remote control distance of wireless remote controller ranges from 100m to 1000m as per different environments. Be sure to properly set certain functional operation of certain button on the wireless remote controller for control of this system in advance. Thus, once this button is pressed, the system will automatically execute preset functional operation.

Select certain remote control number (such as remote control number 1) among the “process serial numbers” on the left side in case of setting. After that, set control items in the functional setting block on the right side. For instance, if remote control number 1 is to be selected to control play of audio source :CH1” in zone 1-10, just click “Zone Selection” button to enter zone selection interface after selection of “remote control number 1”. Distribute audio source “CH1” to zone 1-10 as per audio source distribution mode on the interface before exiting the interface. If “remote control number 1” is requested to control play status of audio source, just enter the “Audio Source Setting” interface to proceed with various settings of audio source. Setting mode is identical to that for setting of audio sources for timing points. “Remote Control Number 1” is also available for simultaneous control of status of output power supply and bell.

Prompt: One button of wireless remote controller is capable of controlling one or numerous functions of this system. However, all controls should be set here in advance. Operation for selection of zones and programs is identical to that for timing points, which shall not be described herein.

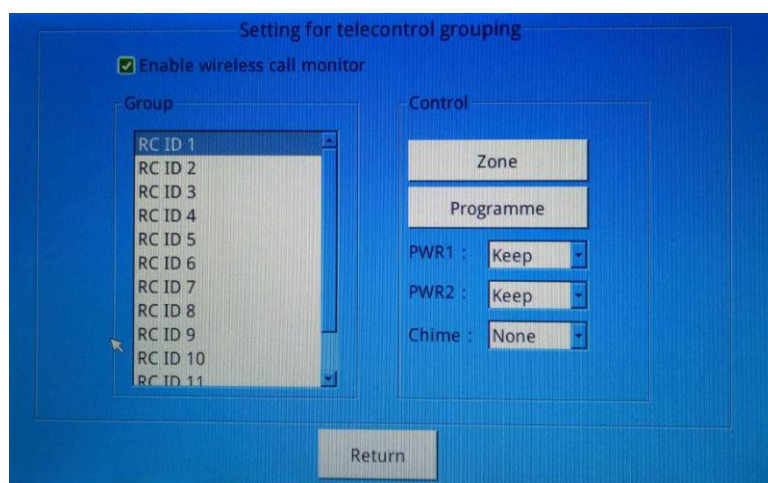

(Figure 22) Wireless group setting

6) Telephone Setting

Click “Telephone Setting” button on the “System Setting” interface to enter telephone setting interface as shown in the

following figure (Figure 23).

The user can set password at discretion on the telephone setting interface. If it is necessary to select use of password, just input 4-digit password in the password input block. In this way, it will be applicable to input password t for calling or paging in case of incoming call.

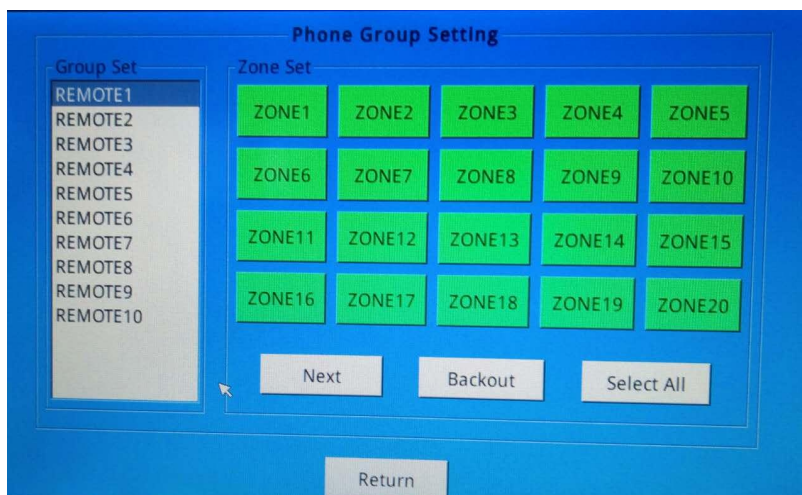

(Figure 25) Phone Setting

Click “Grouped Paging” in the “Paging Setting” block to proceed with grouping for paging zones as shown in the following figure (Figure 24):

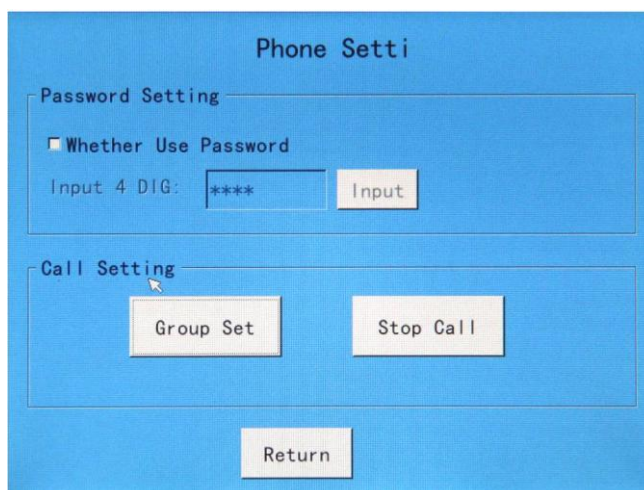

(Figure 24) Telephone Group

Select one certain grouping number below the “Grouped Setting” blocks before click the zone on the right side in case of grouped paging. This zone is to be incorporated into the selected group. One group may include numerous or all zones. This system is available for setting of 10 groups. It is applicable to select grouping number as per voice prompt in case of telephone paging. The system is capable of sending telephone paging to numerous zones simultaneously.

7) Nomination of Audio Sources

Click “Audio Source Setting” on the “System Setting” interface to enter the audio source setting interface as shown in the following figure (Figure 25):

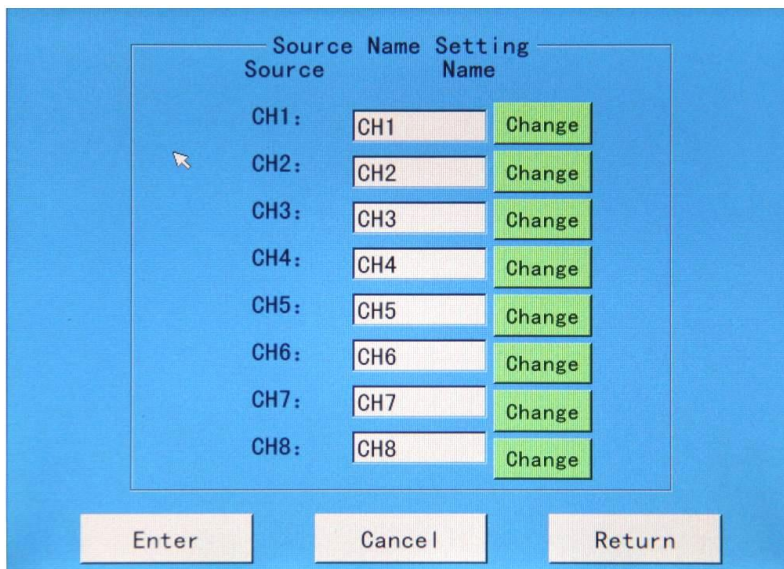

(Figure25) Nomination of Audio Sources

It is applicable to alter or nominate designation of each audio source on this interface. Click the block displaying designation of audio source to select certain audio source (such as CH2), and then click “Alteration” after it to open the input button board. Input designation of the audio source on the button board, and click “Confirm” button to complete nomination of audio source. Once completed, push the “Confirm” button again to return to the system setting interface.

8) Zone Nomination Setting

Click “Zone Nomination Setting” button on the “System Setting” interface to enter zone nomination interface as shown in the following (figure26)

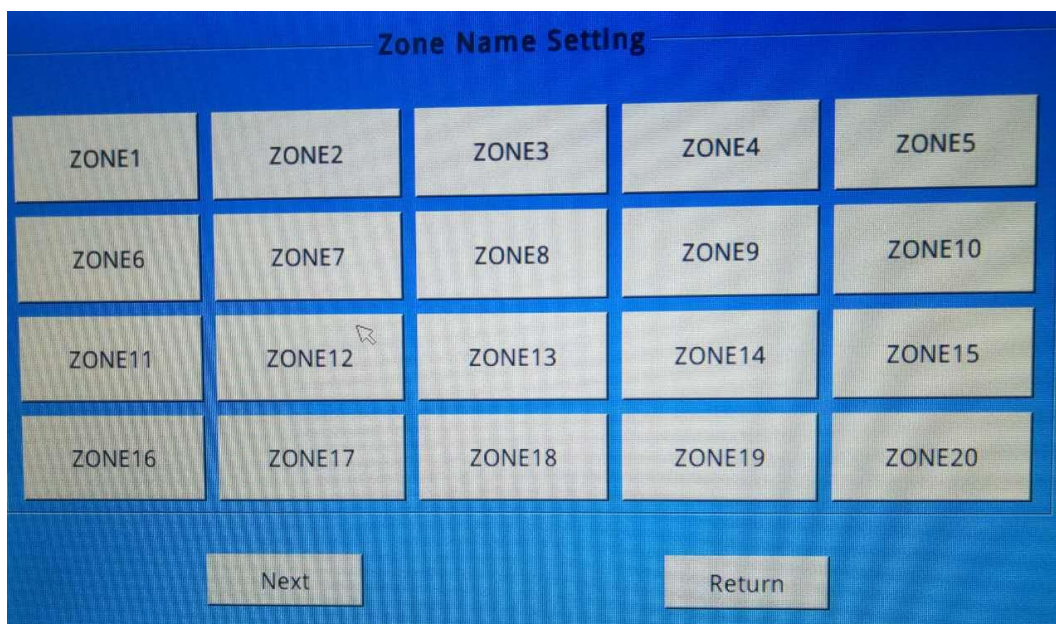

(Figure 26) Zone Nomination Setting

It is applicable to edit a designation for each zone on this setting interface so as to facilitate edit and management of zones in this function. Click the zone for designation editing to enter designation editing button board in case of setting. Input zone designation on the button board, and click “Confirm” button to exit the button board to complete nomination of the zone.

9) IP address Setting

As following(Figure 27),in the "system setting", click "interface IP address settings" button, enter the IP address setting interface, you can modify the IP address, sub-net mask, the gateway, remote control port. When you want to set in operation, (for example, to modify the IP address) ,click the "Edit" button on its back to enter the keyboard input edit interface to modify the IP address, and then click the OK button on the bottom to complete the IP address change. And exit the editor keyboard interface, other modifications are of the same operation set.

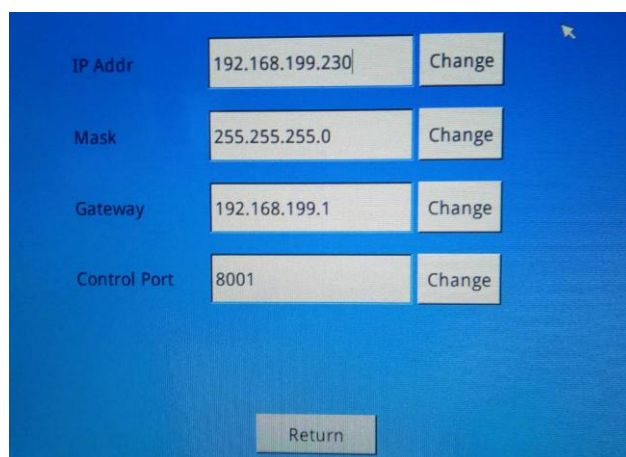

10) Network Timing

In the system settings interface, click on the "network timing" button to enter the interface as following (Figure 28), choose “whether to start using the network timing ”button, set the machine's IP address and IP services in the same segment.

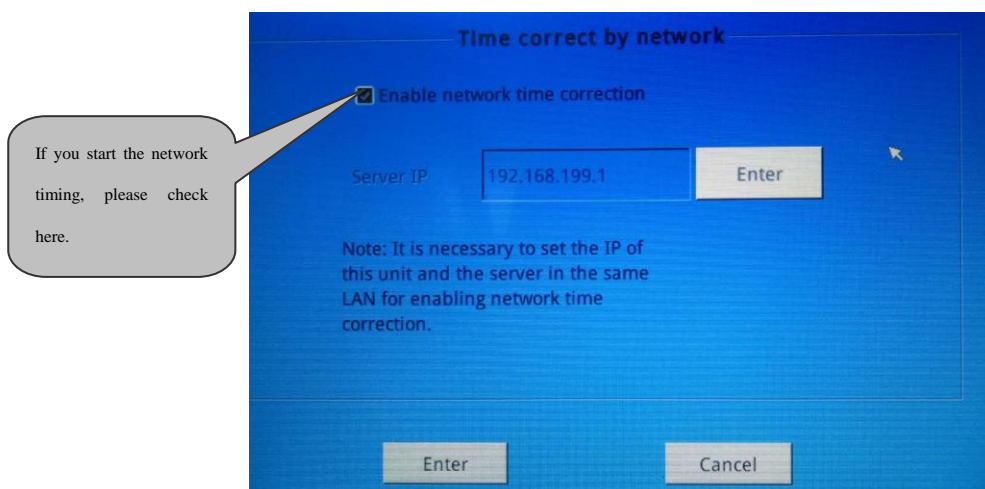

11) Language selection

English and Chinese can be selected here!

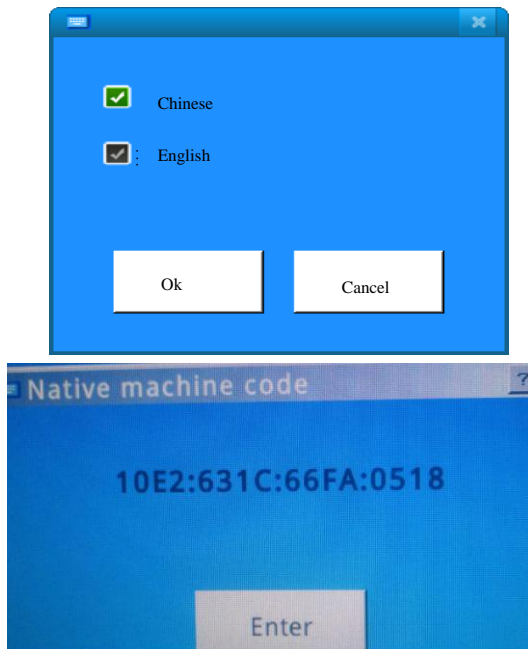

This setting, configuration file are exported to the U disk, import the configuration file to the system and software upgrades, before the operation of this item, insert the U disk.

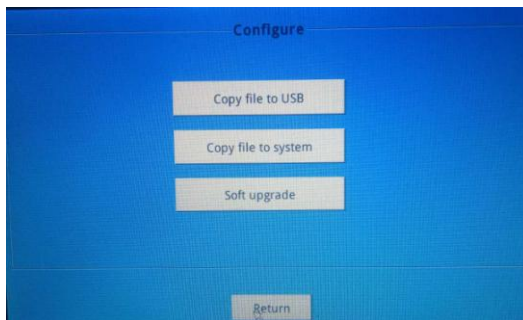

14) Partition volume / volume source

In system settings interface click "partition volume and audio volume "button to enter the partition volume and audio volume interface and have the same in here the partition volume and audio volume mode of operation with the main interface partition volume mode of operation, the operation please reference on the main interface of the partition volume" that part. This will not repeat them.

15) Recording operation

Click the recording operation button on the interface of system settings, entering the following (Figure 29) shows: click on the "recording" button will see “preparing to record, please wait for a moment” .when the recording is finished, click the "stop" button. The recording setup interface will display the recorded file .When recording for the second time, modify the file name first. Selected the file in the box , click the "delete" button can be completed to delete, select the same block in the file, click the "audition" button, you can play. Before the operation, please pay attention to the interface description!



15) System Setting

At the interface you can set the system time, screen protection status and touch screen calibration. The interface is shown below (Figure 30).

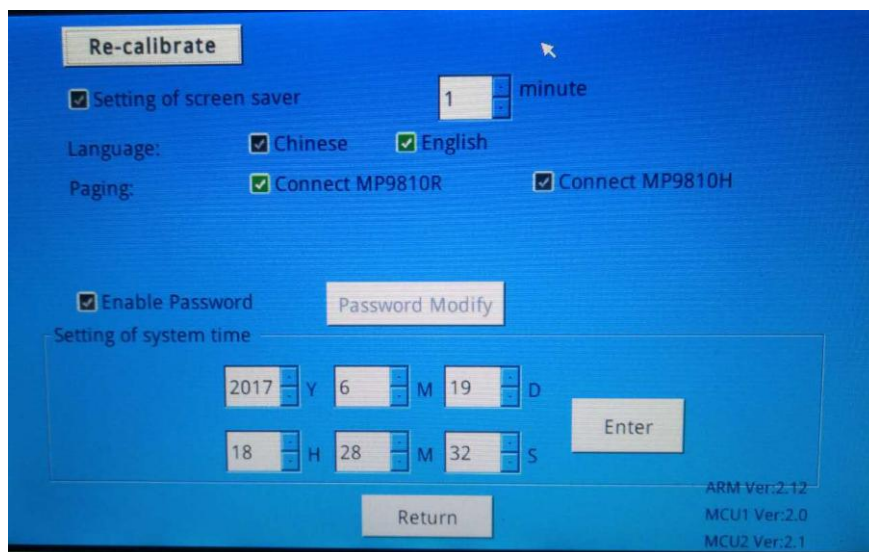

(Figure 30) System setting Interface

To regulate the screen on the touch screen settings, click the “re-regulate” screen will restart the system into the touch screen calibration; select the items on the screen protection settings, after a period of time without any operation, the screen does not display or change any screen protection, until the touch panel on the screen with touch when the screen display again. The protection time can be set, optional period in 1 to 30 minutes. You can also not set the screen saver, this screen from start up to shut down in the open state.

Check “enable the phone to electric tone ”; when there is a telephone coming, there is a voice prompt, the same as wireless key tone. When not checked, no sound.

When setting the system time, please according to the current clock, which is related to the timing of the execution timing .It can be accurate to second. So please pay attention to set the second. When finishing the setting of the system time, press OK button to finish, click the return button to exit the system settings.

6、 Other Functions

6.1 Warning

This machine aims to send warnings to individual or partial or all zones based on the input warning signals. Prerequisite for receiving external warning signals by the machine is stated as follows: It is a must to set warning level properly in “Warning Setting” block on “System Setting” interface (refer to System Setting).

The system will send warning signal to one zone in advance when it is necessary to give warnings to individual or partial zones. After that, this zone will be linked up with adjacent zones to further send warning signals. This machine can also send warning signals to all zones through total warning button on the front panel (refer to Description of Front Panel). When total warning button is used to send warnings to all zones, it will be impossible to operate switches, and distribute audio sources until the total warning button ejects. Priority of warnings to individual or partial or all zones is next to signals from aviation microphone. In other words, no action is able to terminate or cover warning action except for signals from aviation microphone.

2. Paging

This system can send paging to corresponding zone through remote pager or aviation microphone on the front panel.

1) Paging with aviation microphone: Signals from aviation microphone have the highest priority, which can cover all other signals. Be sure to properly connect the microphone, and push the paging button before clicking the target zone for paging. When aviation microphone is used for paging, certain zone playing warning signals will be automatically switched to aviation paging status. Except for the zone subjecting warning, status of other zones is unavailable for auto switching, which requires manual clicking. Once paging by aviation microphone is completed, all paged zones will be switched to the status before paging automatically, including warning.

2) Paging through remote pager: Connect remote pager (refer to Introduction to Rear Panel),

and select target zone on the remote pager to send remote paging to corresponding zone in this system. With regard to method for paging with remote pager, please refer to Operation Instructions for Remote Pager. Remote paging signals have level 3 priority, which can cover signals of telephone paging and background audio source.

3) Telephone paging: It is necessary to proceed with setting of relevant issues concerning telephone paging in “Telephone setting” block on “System Setting” interface before telephone paging, including grouping and password. For setting methods, please refer to Telephone Setting. Telephones on this machine fall into 10 groups. It is applicable to input grouping number directly on the telephone set as per voice prompt in case of telephone paging. For instance, press figure “8” on the telephone set and “#” for paging the 8th group. Be sure to input password as set during “Telephone Setting” before further inputting the target group for paging. Telephone paging has level 4 priority, of which signals can cover signals of background music.

3. Priority Sequence

Priority level of this system is in the following sequence: aviation microphone---warning---remote paging---telephone paging---background music. Signals of higher priority will cover lower ones for prior output. Signals of lower priority will be automatically recovered once those of higher priority are sent.

4. Calibration of Touch Screen

Touch point on the touch screen will be unavailable for accurate shift to the operating option due to rise in temperature or other factors after the machine is operated for a certain period of time. It is applicable to calibrate the touch screen with the following methods under such circumstance.

1) Touch “System Setting” option on the main interface to enter the system setting interface. Touch “System Setting” option on the option interface to enter the interface of screen calibration and time setting.

2) Touch the “Touch Screen Re-calibration” button on this interface to restart the system, and enter the screen calibration interface (as shown in the following figure).

3) Click the center of cross icon with nib on the screen calibration interface (note: be sure to click the center).

4) Proceed with aforesaid calibration at four corners and center of the screen. Otherwise, it will be unable to shift the cursor to the designated option during operation. Under such circumstance, it is applicable to connect USB mouse to restart screen calibration on the screen calibration interface.

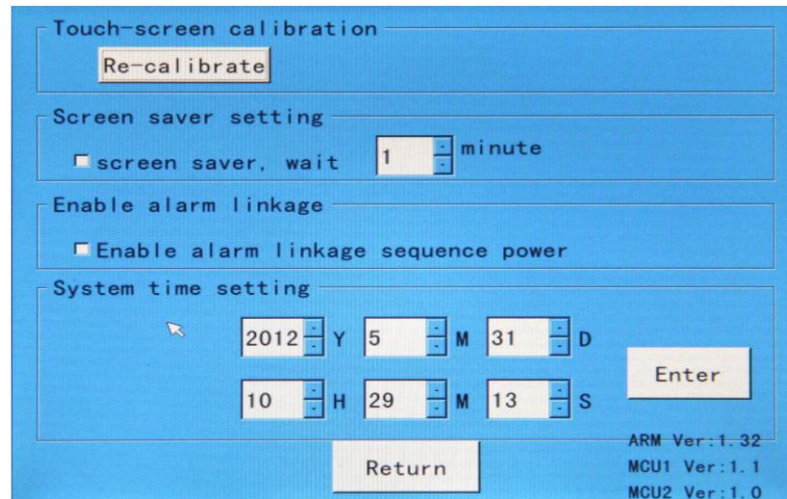

Screen Calibration and Time Setting Interface

Note: It is only applicable to use nib to click the center of cross icon during screen calibration. Never touch the touch screen with body or other objects. Otherwise, it may result in failed screen calibration. Under such circumstance, it will be impossible to use cursor to select the designated option in the system.



Touch screen calibration interface

Packing list

NO.	List	Quantity
1	MAG2140II (MAG2120II)	1
2	Touch pen	1
3	MP-P National standard power line	1
4	FM antenna	1
5	AM antenna and antenna pedestal	1
6	Hardware MP9908 flat cover	1
7	SY564 line (Crystal serial port)	1
8	SY542 audio line	2
9	Wireless receiving antenna	1
10	12 remote wireless remote control	1
11	M5×19 cup head cross screw	4
12	2 meters telephone line with crystal head	1
13	White washer	4
14	CB100 Microphone (with plug)	1
15	Certificate	1
16	Guarantee Card	1
17	Manual	1

Specifications

Model	MAG2120II	MAG2140II	
No. of control zone	20	40	
Display	5.6-inch color screen		
Control mode	Touch screen/remote control/wireless control		
Input sensitivity	250mV(±25mV)		
Output	1V(0dBV)		
Built-in audio source	Radio, MP3		
MP3	Frequency response	20Hz-20kHz	
	SNR	85dB	
	Dynamic range	90dB	
	Harmonic distortion	0.05%	
Radio	AM	Sensitivity	52dBu
		Receiving range	522kHz-1620kHz
		Transmission band	6kHz
		SNR	35dB
	FM	Sensitivity	26dBu
		Receiving range	87.0MHz-108.0MHz
		Transmission band	15kHz
		SNR	75dB
Wireless control	12 unit with control distance within 100-1000m		
Frequency response	20Hz-20kHz(±3dB) (individual zone)		
SNR	85dB		
Cross talk	70dB		
Warning mode selection	Low level is 0V; high level is 5V~24V		
Timed power output	PWR1	AC220V/50Hz/500W	
	PWR2	AC220V/50Hz/500W	
Fuse	Local protection	F1AL	
	Power source protection	F10AL	
Power source	AC220V (±10%) /50Hz		
Gross power	22W		
Packing size (mm)	(L×W×H) 555×460×235		
Machine dimension (mm)	(L×W×H) 484×360×132		
Gross weight	11.8kg	12.3kg	
Net weight	9.2kg	9.6kg	

Any alteration to specifications shall not be notified otherwise.

1 Safety Precautions

- Do not plug the power plug of the device into the power grid without connecting the system line.
- Make sure the voltage input equipment and the equipment requirements are exactly the same, or risk burning equipment.
- The machine has the dangerous voltage, the voltage is sufficient to cause an electric shock, do not open by yourself, so as to avoid the risk of electric shock.
- When the power of the equipment switch in the "off" state, the machine did not appear to be associated with power grid disconnected completely, for the sake of safety, please will the power line plug out of the socket when you do not use it.
- Do not place equipment placed with cold or hot.
- Make sure that the equipment working environment in good ventilation, in order to avoid the damage to the machine caused by the work of fever, high temperature.
- Pull out the power plug when in the cloudy wet weather or do not use the machine for a period of time.
- Take down or reset any parts of the equipment, cut off or re-connect any electrical plug, or before other connections, be sure to pull out the power plug to ensure the device completely separate from the grid.
- In order to avoid the accident or aggravate the extend of the damage, When the equipment is in trouble; do not open the enclosure privately without any professional permission.
- Don't put any corrosive chemicals on or near the top of the equipment.

2. Precautions for After-sale Services

- Our company will provide three-year free guarantee (including free replacement of parts) for any quality problem as occurred during regulated installation and normal operation as per operation instructions from the date of purchase.
- Any user enjoying the free guarantee is requested to present receipt of the warranty card and invoice.
- The following cases are not covered by free guarantee:
 - (1) Damages to products due to incorrect installation, operation or handling;
 - (2) Damages to products by any abnormality (such as over-voltage or extremely high ambient humidity);
 - (3) Damage as incurred by such incidents as natural and man-made disasters to products.
 - (4) Product number has been changed, altered or deleted;
 - (5) The product was once repaired or refitted by personnel not authorized by the company;
- Please properly keep the operation instructions and warranty card.
- With regard to issues or precautions not mentioned in the operation instructions, please contact corresponding distributor or visit official site of the company---<http://www.dsppatech.com>
- Please contact service personnel of our company (or distributor) for processing in case of fault during guarantee period. Our company shall not guarantee any damage as incurred by unauthorized dis-assembly or repair by other technicians.

ATTACHMENT

Notes on the application of U disk file format:

1. Due to the rapid development of the U disk and various type of memory and the market is complex and chaos, this product may not be compatible with all brands, models and specifications of the U disk on the market. In order to ensure read U disk information normally, it is recommended to use 1g-16g capacity of the U disk (e.g. Kingston) 1g-16g and regular brand authentic U disk (such as the Taiwan Power Lenovo/ / flash DI / Kingston etc.) on the machine. This system only supports MP3 file format, the highest rate of 320KBPS, the other format of the audio file cannot be played, if you find that some songs cannot play, you can see if the song is in line with the requirements.

2. Support FAT32 and VFAT file system.

3. In order to improve the speed of operation and optimize management, it is recommended that you use the U disk only to retain MP3 songs, it is best not to store other files, so as to improve access speed and easy to edit the timing point.

4. Please do not save a song directly into the U disk root, please create a folder in the root directory when copy the program by U disk, and then copy the songs to the new folder. This system in the root directory of up to 99 level directory, each directory up to store 99 songs.

Note: Do not crate new sub directory under the first level directory otherwise the songs will not be able to read. You can use the following three ways to store

1. Songs can be stored in the first level directory, the advantages is the song can be stored classified and can be stored up to 99 x 99 songs.

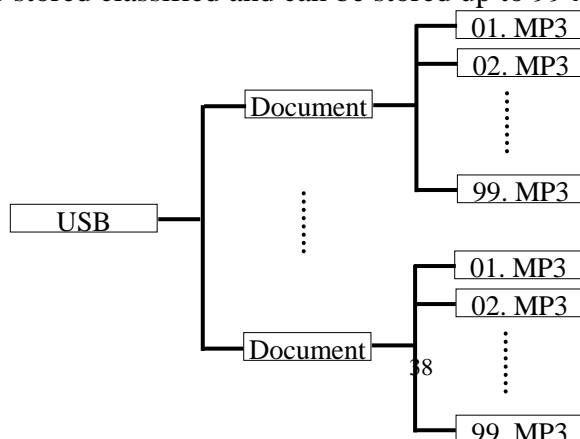

Remote Control (Optional)

1) Installation of Remote Control Computer Software

LAN interface can be connected with computers to realize remote control of the host computer through control software (realize auto play of fixed programs at fixed time and place). (Such function is to be realized by remote control software separately purchased).

Any system installed with remote control software is to be attached with a remote control software installing CD at the time of delivery. Insert this CD into the CD-ROM to install the software in the computer according to prompts. Installation procedures are stated as follows:

- Initiate installation program to enter the interface as shown in the following figure:

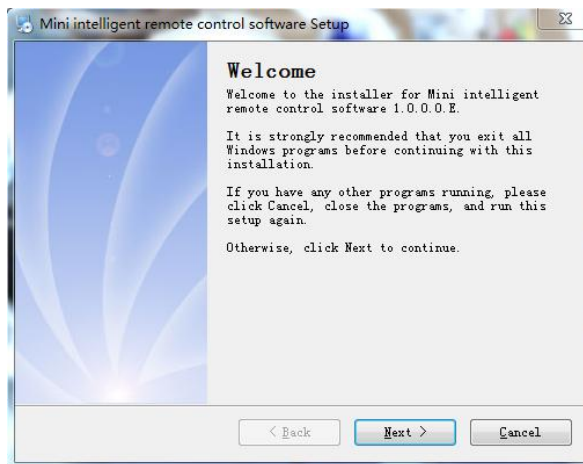

Click "Next" on this interface to enter the follow-up installation interface.

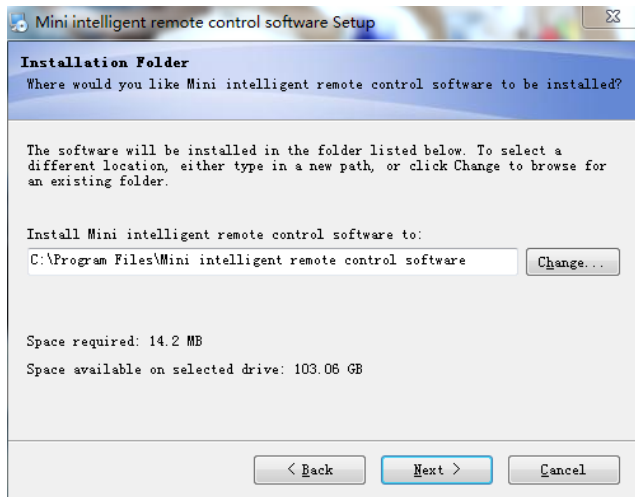

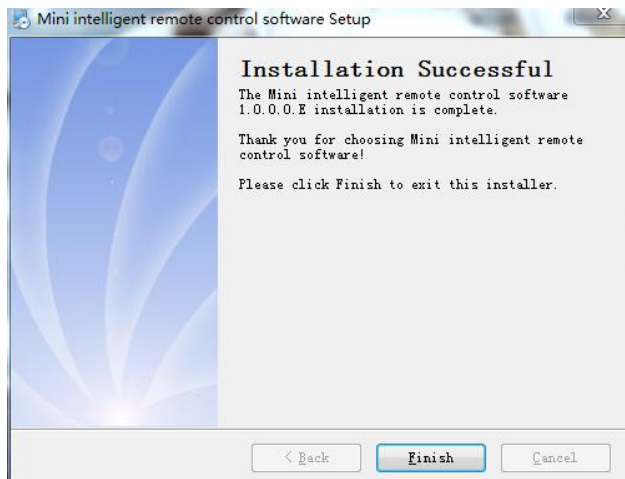
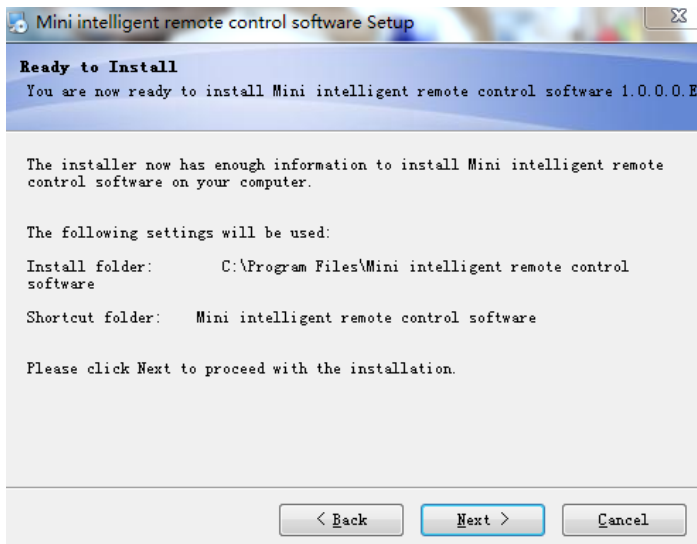

Click "Finish" and the installation will be done

2. Computer remote control

After finishing the installation of remote software with computer controller, it will generate a shortcut icon on the desktop; double click the icon to enter the next one interface:

2.1 Remote Control Operation

System control interface as shown in the aforesaid figure can be used for setting of audio matrix to distribute 10 audio sources to 40 zones (20 zones for MAG2120). Operation methods for audio source distributed to each zone are identical to that for the host computer, which will not be described herein.



2.2 Timing Point Setting and Synchronization

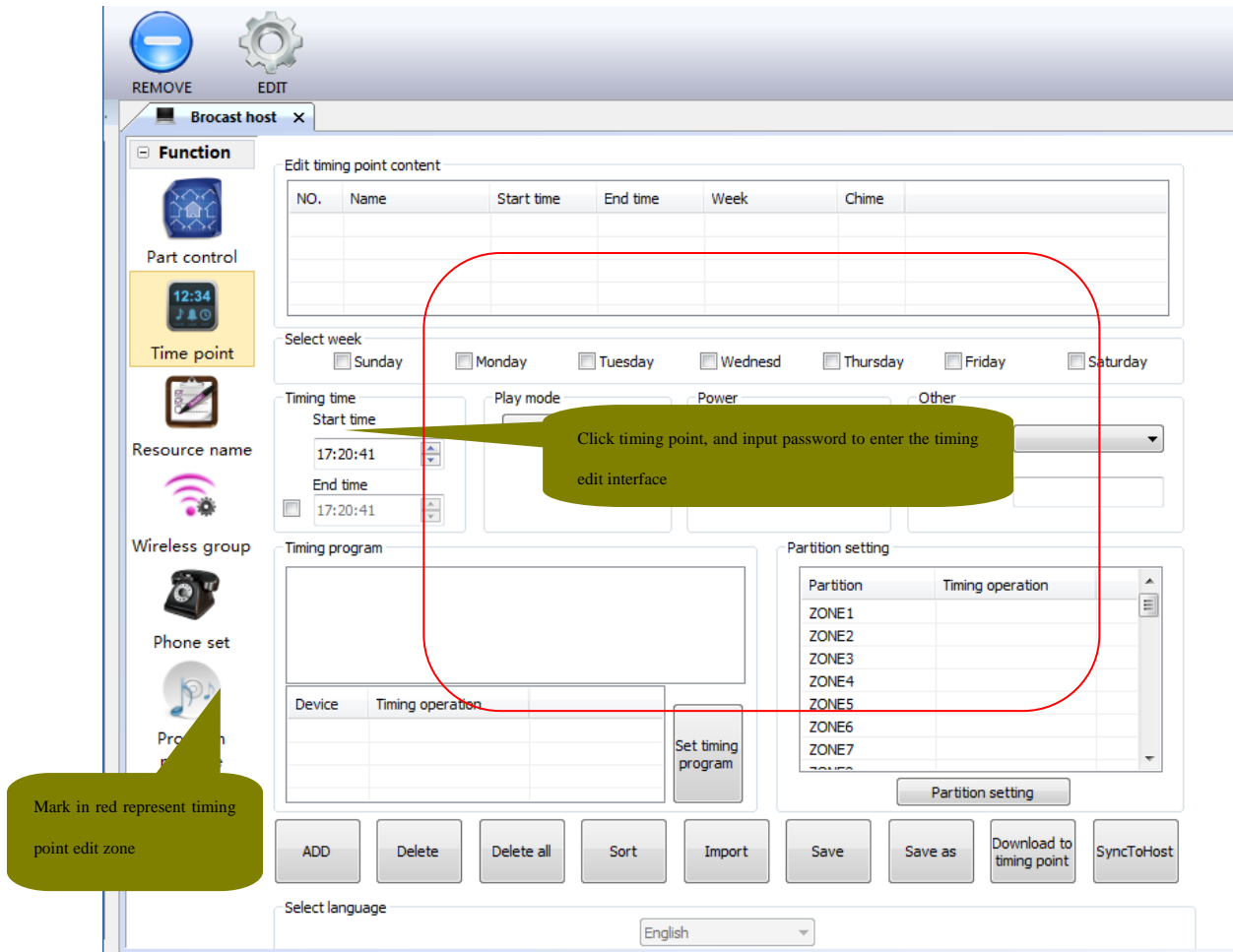

1. As shown in the aforesaid figure, all timing points as edited are displayed in the list. Click options in the list for setting.

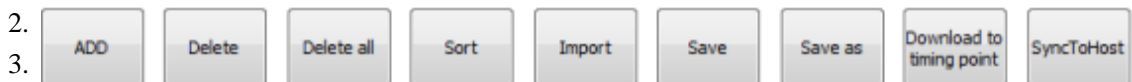

Help information will be displayed automatically when the mouse stops at aforesaid buttons.

4. Add: Add one timing point for auto addition into the list.

5. Delete: Delete one selected timing point in the aforesaid list.



6. Delete All: Delete all timing points in the list. It is applicable to proceed with backup of current timing point by clicking “Save As” before deletion.

7. Ordering: It aims to realize precedence ordering of edited timing points in proper sequence as per commencement time.

8.

“Open”, “Save” and “Save As”: The three buttons are used for backup and recovery of edited

timing points. Shift the mouse to such button to display detailed help information.

9.  Download Timing Points: Download timing points on the broadcasting mainframe to current list.
10.  Synchronization to broadcast: Synchronize edited timing points to broadcasting mainframe.

2.3 Resources Nomination

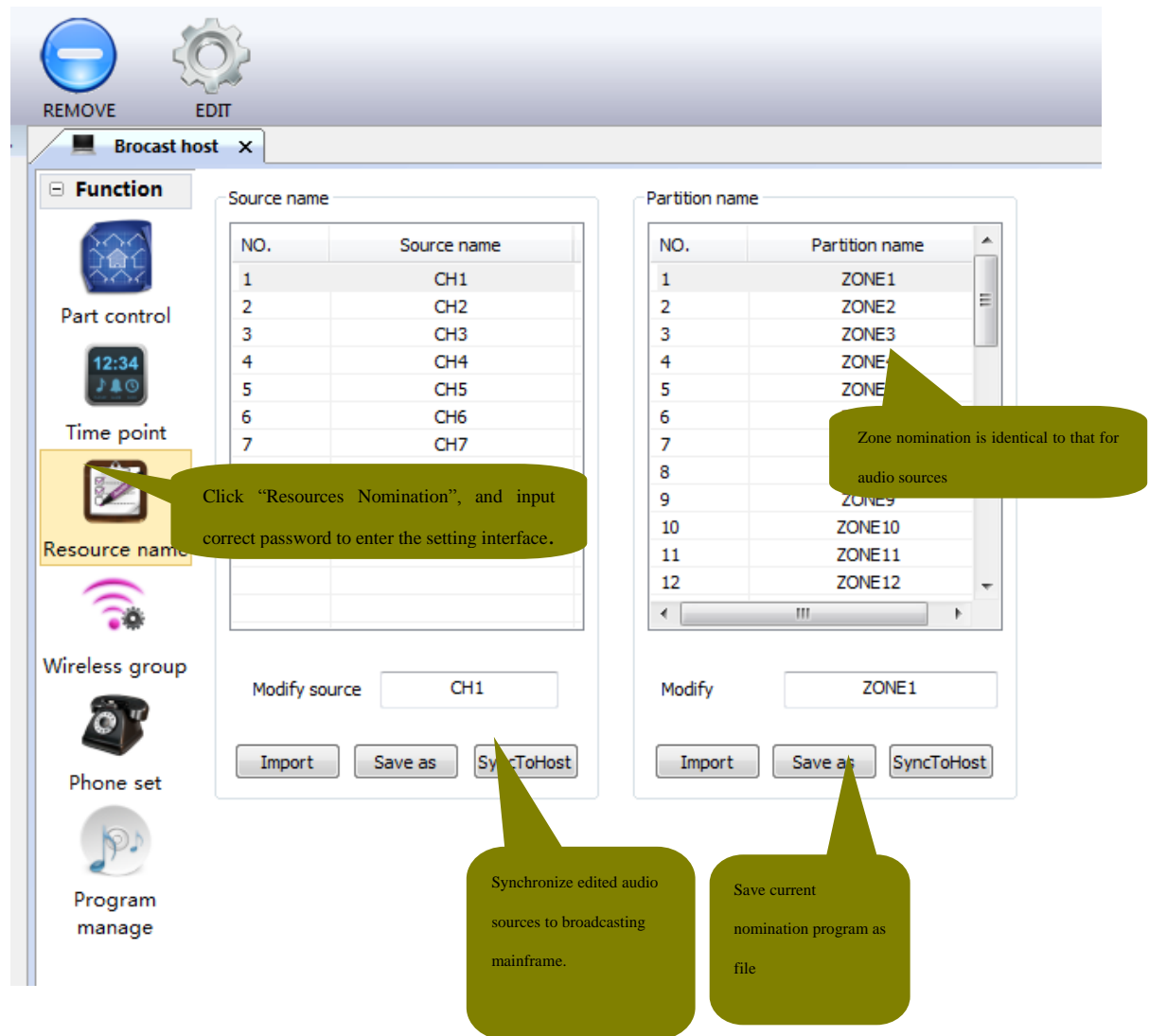

The screenshot shows the 'Broadcast host' software interface. The 'Function' sidebar on the left includes 'Part control', 'Time point', 'Resource name', 'Wireless group', 'Phone set', and 'Program manage'. The 'Resource name' function is selected and highlighted. The main area contains two tables: 'Source name' and 'Partition name'. The 'Source name' table has 7 rows with source names CH1 through CH7. The 'Partition name' table has 12 rows with partition names ZONE1 through ZONE12. Below each table are 'Import', 'Save as', and 'SyncToHost' buttons. Callout boxes provide instructions: 'Click "Resource name", and input correct password to enter the setting interface.' (pointing to the 'Resource name' button), 'Zone nomination is identical to that for audio sources' (pointing to the 'Partition name' table), 'Synchronize edited audio sources to broadcasting mainframe.' (pointing to the 'SyncToHost' button), and 'Save current nomination program as file' (pointing to the 'Save as' button).

NO.	Source name
1	CH1
2	CH2
3	CH3
4	CH4
5	CH5
6	CH6
7	CH7

NO.	Partition name
1	ZONE1
2	ZONE2
3	ZONE3
4	ZONE4
5	ZONE5
6	ZONE6
7	ZONE7
8	ZONE8
9	ZONE9
10	ZONE10
11	ZONE11
12	ZONE12

2.4 Wireless Grouping Setting

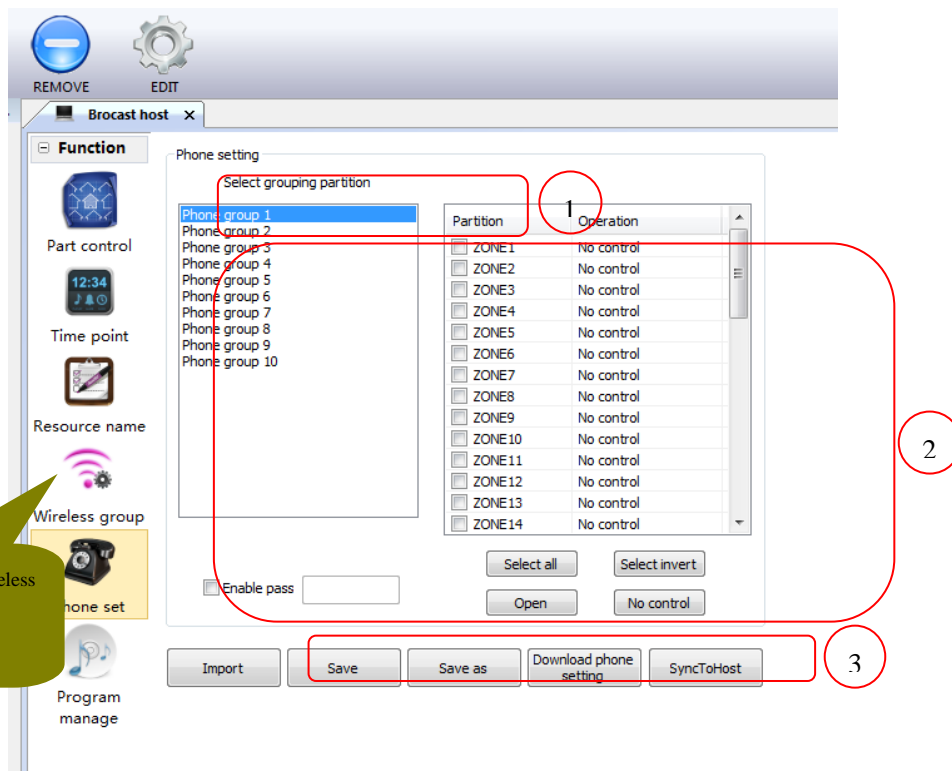

As indicated by the icon, wireless grouping falls into 3 steps:

- ① Select remote control key for setting.
- ② Display selected information on remote control key for direct setting on such interfaces.
- ③ Use such buttons to realize such functions as backup, recovery and synchronization once all wireless groups are edited.

2.5 Telephone Setting

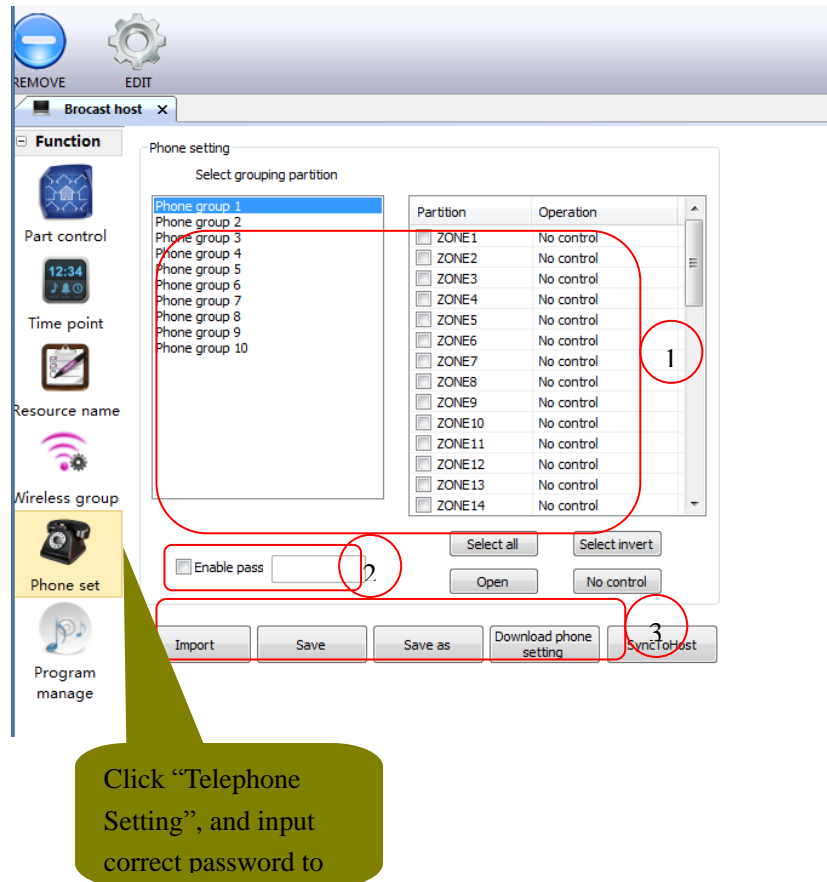

As shown in the figure:

① This zone is for telephone grouping setting. Click grouping list to select corresponding group for setting, and then click zone list setting to see if it has been opened.

② This zone is for setting of telephone password. It is applicable to set password and forbidden/invoation password.

③ This zone is for saving, open and synchronization of edited settings to the mainframe. Click such buttons to realize this function.

2.6 program management



3. Remote Control Software for Android System

3.1. Installation

3.1.1 Installation File

Any user having purchased micro intelligent remote control software can find the file entitled “micro intelligent mobile phone installation pack.apk” in the CD (“micro intelligent tablet installation pack.apk for Android system tablet). This file can be uploaded to the Android mobile phone (tablet) through USB or in other modes.

3.1.2 System Requirements

As tested, the software can support mobile phone system (tablet above version 3.0) above Android 2.1. Please do not hesitate to contact use, and indicate mobile phone model and system version if your mobile phone (tablet) is not compatible with this software.

3.1.3 Installation Procedures

Open the installation file entitled “micro intelligent mobile phone installation pack.apk” on the mobile phone (tablet) to enter the following interface. Click installation button for installation. Be sure to click “Open” button after network setting upon completion of installation.



3.2. Network Setting

It is applicable to control micro intelligent mainframe through WIFI and 3G network. As requested by 3G network, any user should have an IP for static public network as distributed by network supplier. However, dynamically distributed IP such as ADSL is not applicable. Please contact relevant network administrators.

3.2.1 WIFI Control

3.2.1.1 Equipment Requirements

Android mobile phone (Android system tablet), micro intelligent mainframe and wireless router.

3.2.1.2 Setting Methods

(1) Refer to operation instructions for micro intelligent mainframe, and click IP setting button on the system setting interface to enter mainframe IP address setting interface. Properly set IP address and remote control port of micro intelligent mainframe. For instance, IP address and port of the mainframe can be set as 192.168.1.211 and 8001 respectively.

(2) Connect mainframe with network of wireless router.

(3) Open WIFI on the mobile phone (tablet), and make sure that IP addresses of the mobile phone and micro intelligent mainframe are on the same network section. For instance, mobile phone can be set as 192.168.1.2.

3. Android Mobile Phone Software/Mobile phone software

3.1 Installment

3.1.1 Install files:

After the user buys the micro intelligent remote control software, find a file named "micro intelligent installation package.apk" in the disc. Uploaded to the Android phone (tablet) via USB or other means.

3.1.2 System requirements

After testing, the software supports more than Android2.1 version of the mobile phone system (version 3.0 and above the tablet), if the mobile phone users (flat) cannot install this software, please contact us in a timely manner, and explain the phone model and system version.

3.1.3 Installation steps

Open the "micro intelligent installation package.Apk" installation file, the following interface will display, click the Install button to install, after the installation is completed, do not click on the open button, and then set up a good network.



3.2 Network Setting

3.2.1 WIFI Control

(1) equipment requirements

Android mobile phone (Android system), micro intelligent host, wireless router.

(2) Setting method

① Read the micro smart host instructions for reference click the IP settings button in the system settings, enter the host IP address settings interface to set micro intelligent host IP address and remote control port. Such as: set the host IP address for 192.168.199.251 port: 8001.

② Connect the host to the network in the wireless router.

③ Open the WiFi on mobile phone (tablet), ensure that the IP address of the mobile IP address and micro intelligent host in the same segment. Such as: set the phone to 192.168.199.

3.3 Android tablet / mobile phone software instructions

Enter the control interface as shown in the following figure following successful operation of the software:

1) Network Setting

After the successful installment of the software, it requires registration when it is used for the first time after connection. So it is in offline state before the connection is

not registered.

Input the serial number in the sequence number column as shown below, and then click the "register" button. The serial number can be obtained on the CD or the host machine.

Input the IP address in the IP address column (input the host's IP address), the port number to be consistent with the control port number of the host, click on the "registration" button, the input is complete.



Click on "network settings" function module, when the network is not connected, interface display offline, showing as follows. At this time the "offline" button can move in any position, when the registration code and IP address and port number input completed, click "connect" button to connect to the network, after a successful connection, as follows the right edge of the chart shows, it will display connect to the network successfully.



2) Remote Control

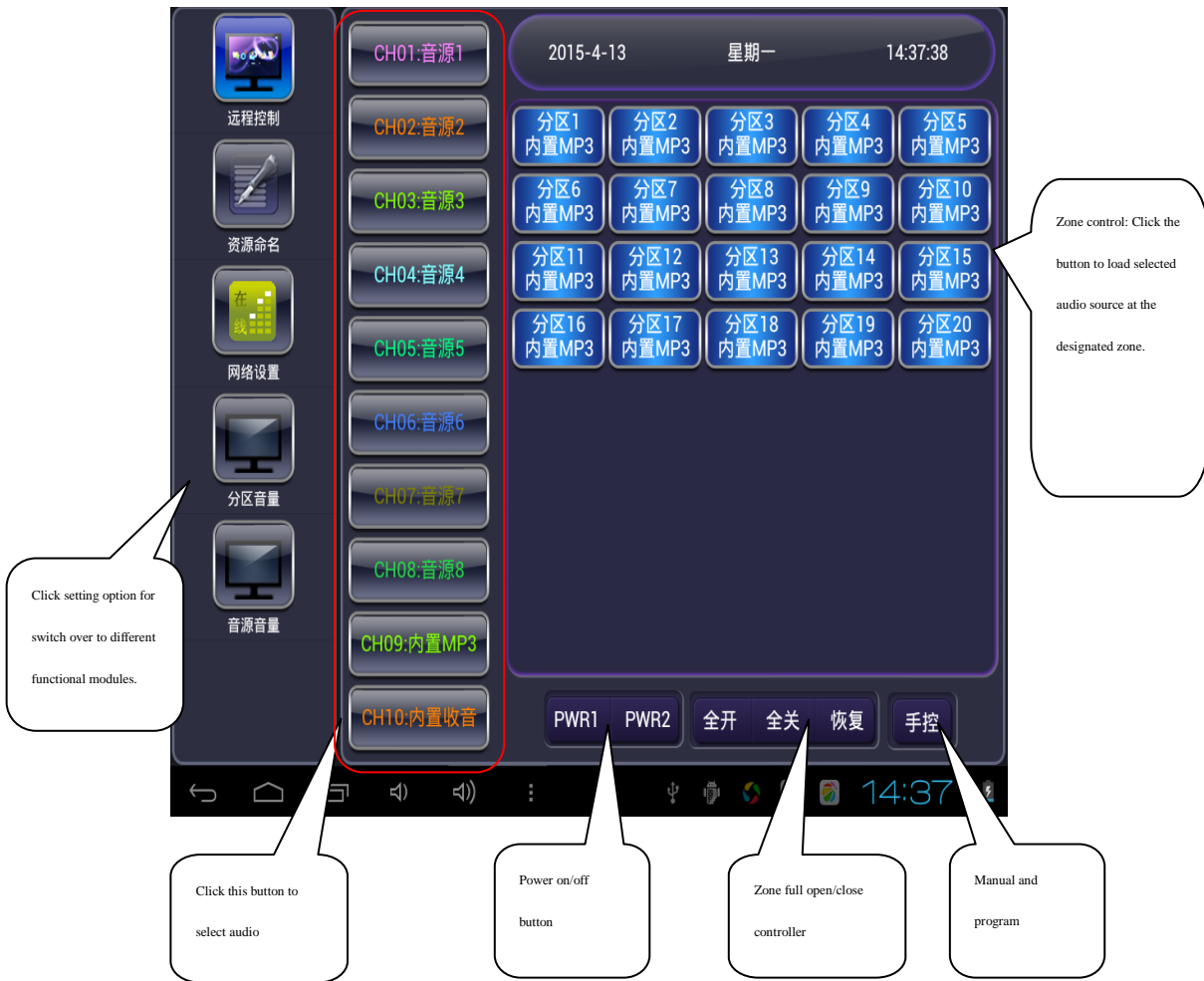

3) Nomination of Audio Sources

Click here to select audio

Click the selected partition name

音源命名		分区命名	
序号	音源名	序号	分区名
1	音源1	1	分区1
2	音源2	2	分区2
3	音源3	3	分区3
4	音源4	4	分区4
5	音源5	5	分区5
6	音源6	6	分区6
7	音源7	7	分区7
8	音源8	8	分区8
		9	分区9
		10	分区10
		11	分区11
		12	分区12

输入音源名：音源1 确定 输入分区名：分区1 确定

同步到广播 同步到广播

Synchronize the modified audio source to broadcast

Synchronize the modified partition list to broadcast.

4) Partition volume

Click to select the partition

Adjust the volume

Adjust the partition volume balance

Click the "submit" button after setting.

分区1 50 分区2 50 分区3 50 分区4 50 分区5 50

分区6 50 分区7 50 分区8 50 分区9 50 分区10 50

分区11 50 分区12 50 分区13 50 分区14 50 分区15 50

分区16 50 分区17 50 分区18 50 分区19 50 分区20 50

音量 50 提交

0 5 -2 5 0 (dB)

100 330 1K 3.3K 10K (Hz)

全选 取消

5) Audio Volume

